



HIGH-VISIBILITY HANDBOOK



A KLEIN TOOLS COMPANY

SOLUTIONS, SUPPORT AND OUR COMPLETE HI-VIS LINE-UP

BE SEEN. FEEL HEARD.

WITH A RESPONSIVE, FULL-SERVICE HI-VIS PROGRAM THAT WORKS FOR YOU.

Any knucklehead can slap some silver tape on neon mesh and call it a day. But the truth is, “worker safety” and “lowest bidder” go together as well as orange juice and toothpaste. Or nuts and gum. Or reasonable debate and Thanksgiving with Uncle Larry the conspiracy theorist (turns out proving the world ISN'T ruled by an elite group of reptiles secretly led by Justin Bieber is harder than you think).

Anyway, on the flip side of all that is a responsive, full-service program that works for you. An extension of our decades' long obsession with helping Make the Workplace a Betterplace™. Whatever it takes. Sure, that means the most Tenacious Work Gear® on the planet. But it also means a deep, fine-print level understanding of standards & risk, matched with an eagerness to help solve your unique end-to-end challenges—from spec to supply chain.

So whether it's considering your crew's compliance down to the last square inch of fabric (hey, it's a fine line between nerdery and tenacity) or partnering to create just the right solution to reflect the realities of your worksite, we're here—and we've got your be-seen back.

[CLICK TO VIEW FULL GLOWEAR LINE >>](#)



8283BK

WHY ERGODYNE Pg. 4-5

YOUR PARTNER IN SHINE SINCE 1983

Activate a hi-vis partner who knows, cares and dares to put your success over all else.

INNOVATION BY COLLABORATION Pg. 6-7

THE BRIGHTEST IDEAS IN HV START WITH YOU

Go beyond “being seen” with hi-vis gear built in collaboration with folks like you.

HI-VIS STANDARDS Pg. 8-9

EASY AS 1-2-3 (E-O-R-P)

HI-VIS SELECTION

WE’VE GOT YOUR BE-SEEN BACK

Any job. Any budget. Whatever your hi-vis needs, we’ve got you covered.

CLASS 1 & NON CERT	Pgs. 10-11
CLASS 2 VESTS	Pgs. 12-15
CLASS 3 VESTS	Pgs. 18-19
FR VESTS	Pgs. 20-21
PUBLIC SAFETY VESTS	Pgs. 22-23
SHIRTS & SWEATSHIRTS	Pgs. 24-25
JACKETS	Pgs. 26-27
PANTS, BIBS & GAITERS	Pgs. 28-29
HEADWEAR & ACCS.	Pgs. 30-31
RAINWEAR	Pgs. 32-33

SERVICE LIFE Pg. 16

YOUR POINT OF PRIDE IS MISSING THE POINT

CUSTOM LOGO PROGRAM Pg. 17

MAKE YOUR MARK

Mmm... smells like team spirit. Submit your design or use one of our ready-made templates.

COLLECTION INDEX Pg. 34-47

TENACIOUS WORK GEAR Pg. 48-49

BUT WAIT! THERE’S MORE!

YOUR PARTNER IN SHINE

**Did you know all Class 2, Type R garments require 201 square inches of reflective?
Or that there isn't an orange flame-resistant fabric in existence that's ANSI
107-approved?**

Gold star if you did. But if not, we're here to translate the tough stuff to make sure every crew you serve is always compliantly up to code with solutions that meet the demands that matter most. Yours.



“From helping maintain compliance and working closely with us to develop the best possible solutions to fit our very specific needs. Ergodyne’s hi-vis program is second to none.”

- Leading Airline Safety Director

WHY ERGODYNE // YOUR PARTNER IN SHINE

WHY US?

BECAUSE WORKER SAFETY IS NOT A COMMODITY

In a world where daylow grifters and bottom-dollar bidders would lead you to believe it's all the same, we're out to prove that saving a few dimes on the front end isn't worth the inevitable bite in the back end.



INNOVATION

Why stop at “being seen” when you can turn this staple of personal protective equipment into personal *productivity* equipment? Through far-out performance fabrics and above-and-beyond design features, we’re helping create crews of shiny happy people with mindfully crafted, high-quality gear.

COLLABORATION

From hi-vis development and testing to risk assessment and identifying compliance gaps in your existing hi-vis program, everything we do is driven by a commitment to deeply knowing what you and your crew are up against day after day.

EDUCATION

If you find the subtleties of hi-vis standards easy to miss, no worries. You’re not the only one. In fact, we’ve helped some of the biggest organizations in the world get up to code with a deep-seated knowledge built over 20+ years on the ISEA/ANSI 107 Hi-Vis Product Group Committee (the group that helps inform, shape and revise the hi-vis standard).



THE BRIGHTEST IDEAS IN HI-VIS START WITH YOU

When it comes to churning out space-age hi-vis that surpasses everything else on this brilliant blue planet, we can't take all the credit. Admittedly, our brightest ideas come from you.



AMAZING VEST

5 STARS (MORE IF POSSIBLE)

“The vest is 100% comfortable. I love how breathable it is. The design is really sleek and not corny like a lot of vests I’ve had in the past.”

- Kyle, Ergodyne.com Reviewer

8231TV TETHER VEST,
DESIGNED WITH
WORKER FEEDBACK



INNOVATION BY COLLABORATION // THE BRIGHTEST IDEAS IN HI-VIS START WITH YOU

INNOVATION BY COLLABORATION

The obvious safety benefit to wearing high-visibility clothing is right in the name. But then what? We dare to ask, you indulge us with the answers. The results? Everything from convenient considerations that turn a tried-and-true safety staple into a mobile workstation to mindful designs that tackle extreme temps or winter walks with the dog.



8321TV TOOL TETHERING VEST

Fusing ANSI 121 & ANSI 107 compliance into an all-in-one at-heights working wonder.



8261FRHL FR VEST

A dynamic duo of arc flash and flash fire protection for hi-vis compliance that's all bright, no burn.



8388 4-IN-1 HI-VIS JACKET

Man vs. Nature vs. Worksite. Only one exits this cage match unscathed. (Hint: It's the one wearing this impossibly versatile, shape-shifting uber-jacket).



8283BK LIGHTWEIGHT PERFORMANCE T-SHIRT

Like a workout shirt for the worksite with underarm vents, moisture-wicking treatment and UPF 30+ to keep crews safely seen and sweat-free when the heat rages on.



6668 HI-VIS COOLING VEST

You know what's the worst during a heat wave? Clothing. Going au naturale ain't an option, but limiting your layers with the coolest hi-vis vest around is.



8377EV THERMAL ENHANCED VISIBILITY JACKET

Maybe the gig doesn't require it. Or maybe you're out for an evening stroll and don't want to look like the safety dork you know you are deep down inside... when a little nighttime shine is needed, this is your play.

VIEW MORE
(TECH PAGE) >>



HI-VIS COMPLIANCE ISN'T ROCKET SCIENCE WHICH IS TOO BAD, BECAUSE THAT'D PROBABLY BE EASIER

Fear not, we're here to break down the standard in simple(r) terms.



ANSI 107 is the industry regulation that sets design requirements and performance testing criteria for all types and classes of high-visibility wear, particularly the amount of required fluorescent background material and reflective to keep workers safe and seen.



PURPOSE



Enhances daytime visibility by adding contrast against background environments

APPROVED FLUORESCENT COLORS



LIME ORANGE RED



PURPOSE



Enhances low-light nighttime visibility by reflecting light back toward the original source

APPROVED REFLECTIVE



SOLID SEGMENTED COMBINED PERFORMANCE



PURPOSE



Creates biomotion that signals awareness to the brain that it is looking at a human

REQUIREMENTS



360° TORSO VISIBILITY, 180° AND 360° VISIBILITY ON SHOULDERS, SLEEVES AND PANT LEGS (DEPENDING ON CLASS)

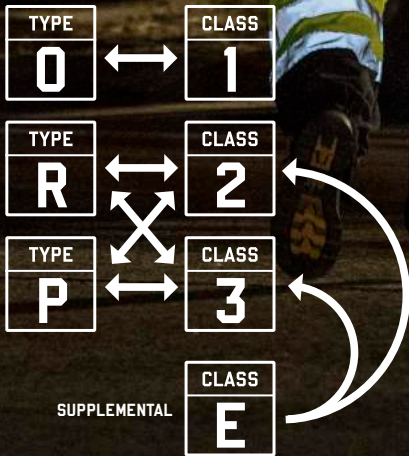

HI-VIS STANDARDS // EASY AS 1-2-3 (E-O-R-P)

ANSI 107 HI-VIS PERFORMANCE CLASSES & TYPES

DID YOU KNOW?
The second digit of our Glowear vest model # dictates what class the item is

8217BA = Class 2

CLASS	CLASS	CLASS	CLASS
1	2	3	E

PERFORMANCE CLASSES

The standard breaks out three types of garments with five performance classes indicating how much of the garment has to be hi-vis material.

CLASS 1
WHAT IT IS
Minimum hi-vis materials needed to differentiate wearer

CLASS 2
VISIBILITY

CLASS 3
REQUIREMENTS

CLASS E

- FLUORESCENT BACKGROUND 217 IN²
- REFLECTIVE 155 IN²
- REFLECTIVE WIDTH 1 IN²

CLASS 1
WHAT IT IS
Additional hi-vis materials for better definition of the human form

CLASS 2
VISIBILITY

CLASS 3
REQUIREMENTS

CLASS E

- FLUORESCENT BACKGROUND 775 IN²
- REFLECTIVE 201 IN²
- REFLECTIVE WIDTH 1.28 IN²

CLASS 1
WHAT IT IS
Most hi-vis materials for best definition in complex backgrounds

CLASS 2
VISIBILITY

CLASS 3
REQUIREMENTS

CLASS E

- FLUORESCENT BACKGROUND 1240 IN²
- REFLECTIVE 310 IN²
- REFLECTIVE WIDTH 2 IN²

+ ADDITIONAL REQUIREMENTS: REFLECTIVE TAPE ON SLEEVES OR CLASS 2 TOP & CLASS E BOTTOMS

CLASS 1
WHAT IT IS
Garments that do not classify when worn alone, but achieve Class 3 when worn with other Class 2 or Class 3 garment

CLASS 2
VISIBILITY

CLASS 3
REQUIREMENTS

CLASS E

- FLUORESCENT BACKGROUND 465 IN²
- REFLECTIVE 109 IN²
- REFLECTIVE WIDTH 2 IN²

TYPE	TYPE	TYPE
O	R	P

TYPES

The standard breaks out the three types of garments into three types of worksite environments.

Type O = Off-Road // Type R = Roadway // Type P = Public Safety

TYPE O
WHEN IT'S USED
For off-road, indoors or controlled environments, parking lots, festivals, extracting/refining oil & gas, warehouse/factories

TYPE R
APPLICATIONS

TYPE P

RETAIL WAREHOUSING

COMPATIBLE WITH

CLASS 1

TYPE O
WHEN IT'S USED
For environments with moving traffic or equipment traffic, minimum level of protection for workers exposed to roadway rights-of-way and temporary traffic control (TIC) zones

TYPE R
APPLICATIONS

TYPE P

CONSTRUCTION TRANSPORTATION AIRLINES

COMPATIBLE WITH

CLASS 2 **CLASS 3**

TYPE O
WHEN IT'S USED
For environments with moving traffic or equipment traffic, emergency/incident response, police, fire, EMS only

TYPE R
APPLICATIONS

TYPE P

EMERGENCY RESPONSE POLICE FIRE EMS

COMPATIBLE WITH

CLASS 2 **CLASS 3**

GLOWEAR® HI-VIS:

CLASS 1 & NON-CERT CATEGORY

Even if you don't have heavy construction hanging over your head or a hard hat job that requires it, GloWear's got your be-seen back. Sure, some of these safety vests are officially labeled non-compliant, but we guarantee they'll reflect well on your innate sense to avoid catastrophe and put safety first. From far-out fabrics and the latest reflective technology to 5-point breakaway and hook & loop closures—nobody brings brighter ideas to visibility than GloWear.



HI-VIS // CLASS 1 & NON-CERT



8020HL



8020HL
VEST, NON-CERTIFIED, HOOK & LOOP, STANDARD



8040HL
VEST, COMBINED PERFORMANCE TAPE, NON-CERTIFIED, HOOK & LOOP



8010HL
VEST, NON-CERTIFIED, HOOK & LOOP, ECONOMY



8080BAX
VEST, X-BACK, NON-CERTIFIED, HOOK & LOOP



8140BA
SASH, BREAKAWAY, TYPE O, CLASS 1

GLOWEAR® HI-VIS:

CLASS 2 CATEGORY

When you're burning the midnight oil on interstate highways and byways, spelunking below the crust of the earth ferreting out the next great mother lode or fixing your burgh's energy grid during a blackout, you need to make sure you're visible. Highly visible. To avoid drama in the darkness, outfit yourself in our ANSI-compliant GloWear safety vest line and become a beacon unto others.

FALL HARNESS COMPATIBLE
BACK/SIDE D-RING SLOT

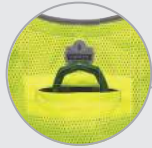

20& TETHERING POINTS ALL
ANSI 121-CERTIFIED TO 2LBS
AND 4-FOOT MAX TETHER



8231TV

VEST, TOOL TETHERING, TYPE R, ZIPPER, DUAL COMPLIANT: ANSI/ISEA 121 AND ANSI/ISEA 107 CERTIFIED FOR DROPPED OBJECT PREVENTION AND HI-VIS COMPLIANCE



HI-VIS // CLASS 2



8205HL/8205Z
VEST, MESH, TYPE R, HOOP & LOOP OR ZIPPER, NO POCKETS



8216BA
VEST, BREAKAWAY, MESH, TYPE R, ID BADGE HOLDER



8217BA
VEST, BREAKAWAY, MESH, TYPE R



8220HL/8220Z
VEST, MESH, TYPE R, HOOK & LOOP OR ZIPPER, STANDARD



8225HL/8225Z
VEST, SOLID, TYPE R, HOOK & LOOP OR ZIPPER, STANDARD



8229Z
VEST, TWO-TONE, TYPE R, ZIPPER, ECONOMY



8230Z
VEST, TWO-TONE, MESH, TYPE R, ZIPPER



8235ZX
VEST, TWO-TONE, X-BACK, TYPE R, ZIPPER



8248Z
VEST, TWO-TONE SURVEYORS, TYPE R, ZIPPER



8250Z/8250ZH
VEST, SURVEYORS, TYPE R, ZIPPER / COMBINED PERFORMANCE TAPE



8253HDZ
VEST, HEAVY-DUTY MESH SURVEYORS, TYPE R, ZIPPER



8256Z
VEST, SELF-EXTINGUISHING, TYPE R, ZIPPER

GLOWEAR® HI-VIS:

CLASS 2 CATEGORY CONT.

ZIPPERED REAR POCKET
DOCUMENT/TABLET



LANYARD GROMMET
HOLES & DUAL
RADIO MIC TABS



8254HDZ

VEST, HEAVY-DUTY SURVEYORS, TYPE R, ZIPPER



6668

CHILL-ITS® COOLING VEST,
TYPE R, ZIPPER

- POLYMER-EMBEDDED COOLING TECHNOLOGY
- ANSI/ISEA 107, TYPE R CLASS 2 COMPLIANT WITH 2" REFLECTIVE TAPE FOR LOW-LIGHT VISIBILITY
- LIGHTWEIGHT & BREATHABLE MESH BOTTOM



- WHEN WET, POLYMER-EMBEDDED MID-LAYER PROVIDES HOURS OF COOLING
- SOAK IN WATER FOR 2-5 MINUTES TO ACTIVATE
- RE-WET TO REUSE



6668





8210HL/8210Z/8210HL-S
 VEST, MESH, TYPE R, HOOK & LOOP OR
 ZIPPER, ECONOMY, DUAL SIZE / SINGLE SIZE



8215BA/8215BA-S
 VEST, BREAKAWAY MESH, TYPE R,
 ECONOMY, DUAL SIZE / SINGLE SIZE



8246Z/8246Z-S
 VEST, TWO-TONE, MESH, TYPE R, ZIPPER,
 REFLECTIVE BINDING, DUAL SIZE / SINGLE
 SIZE



8249Z/8249-S
 VEST, SURVEYORS, TYPE R, ZIPPER,
 ECONOMY, DUAL SIZE / SINGLE SIZE

**PICK
 YOUR FIT**

CHOOSE SINGLE OR DUAL SIZING

SINGLE SIZE has extra length and a more tailored fit
 DUAL SIZE is a looser/wider fit, good for wear with jackets

**SINGLE
 SIZE**

EXTRA LENGTH,
 MORE TAILORED FIT

**DUAL
 SIZE**

LOOSER FIT, GOOD
 FOR WEAR WITH
 JACKETS



MORE SIZING OPTIONS FOR A JUST-RIGHT FIT

Word on the worksite was that hi-vis vest sizing was... inexact. Smalls were too large, larges were too small, cats and dogs living together, mass hysteria!

Well, by adding single size options to the mix, we've answered your call to accommodate those that were swimming in or squeezed by our traditional dual size options. Not too small, not too big... but juuust right. Call it the Glo-dilocks zone.

CLICK HERE to reference our size chart comparison doc for the best fit

BADGE OF HONOR? THINK AGAIN

YOUR POINT OF PRIDE IS MISSING THE POINT

Too cool to wear a bright, shiny (reflective) vest on the job? Afraid you'll look too much like a wide-eyed, coffee-fetching rookie? Time for a reality check, you ol' grizzled vet you. It seems your point of pride is missing the point. If you're not seen, you're at risk. With experience comes wisdom, act like it and stay visible.

CLICK TO READ MORE >>



OLD "NOT SO" HI-VIS



NEW HI-VIS



NO HI-VIS:

// WE'RE NOT EVEN GOING TO ENTERTAIN SUCH A LUDICROUS SCENARIO.



OLD HI-VIS:

// BETTER THAN NOTHING, BUT NOTHING IS A PRETTY LOW BAR. LIKE, THE LOWEST.



NEW HI-VIS:

// HOOD-WEE! AREN'T YOU JUST AN INCREDIBLY EASY TO SPOT SIGHT FOR DISTRACTED EYES?

SERVICE LIFE // YOUR POINT OF PRIDE IS MISSING THE POINT

CUSTOM LOGO PROGRAM MAKE YOUR MARK!



HERE'S THE DRILL: CUSTOM LOGO PROGRAM

Because we have so many options and styles of products available to custom logo, we can do almost anything.

YOU GIVE US:

- Suitable digital art files or camera-ready artwork (EPS-format files work best but large, hi-res TIF or JPG files [300& dpi] work too)
- All necessary PMS/Pantone colors
- Approval of a digital mock-up

WE GIVE YOU:

A product with a look all your own. Minimums vary based on the type of product. Don't worry, it's low.

Call Ergodyne Customer Support today to answer all your custom logo questions... we'll make it easy for you to look good!

[CLICK HERE to view our complete catalog >](#)



GLOWEAR® HI-VIS:

CLASS 3 CATEGORY

Our ANSI Class 3 Series is the north star of our high-visibility line. Brighter than a champagne supernova, these safety vests combine 360° of ANSI-compliant visibility with heavy-duty construction, lightweight breathable fabrics and convenient pockets. When you need maximum visibility, this is the series for you.

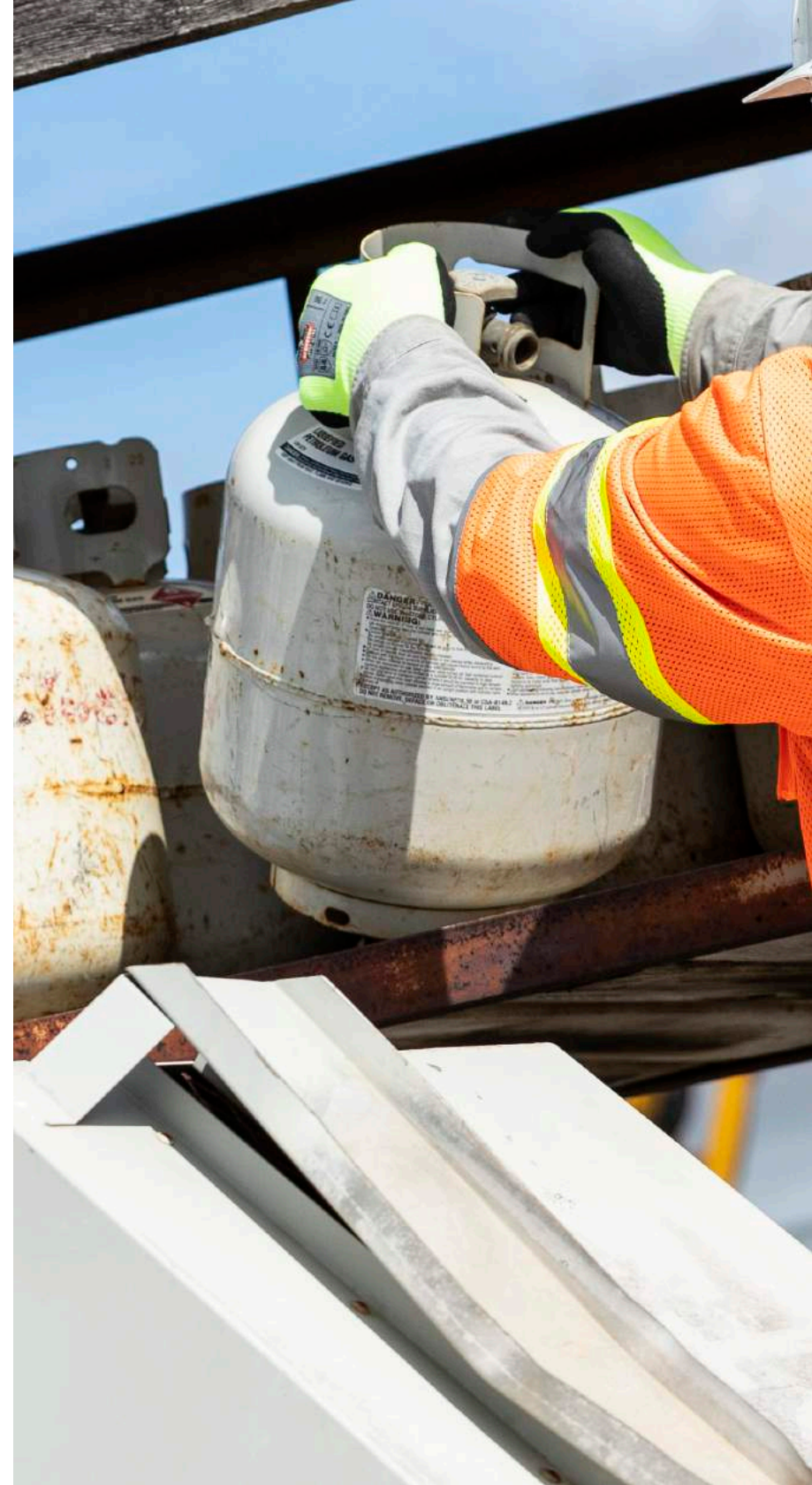

HI-VIS // CLASS 3



8346Z



8310HL
VEST, ECONOMY, TYPE R,
HOOK & LOOP



8320Z
VEST, STANDARD, TYPE R, ZIPPER



8330Z
VEST, TWO-TONE, TYPE R, ZIPPER



8346Z
VEST, TWO-TONE, TYPE R, ZIPPER

GLOWEAR® HI-VIS:

FR (CLASS 2&3) CATEGORY

If it ain't one hazard, it's the mother truckin' other. Just as soon as you stave off struck-by accidents with GloWear's eye-popping ANSI-compliant hi visibility and reflective material, sparks fly. Enter GloWear FR Class 2 and Class 3 Hi-Vis Vests. ASTM F1506-certified to squelch the danger and ensure your day doesn't go up in flames.

FALL HARNESS COMPATIBLE
BACK/SIDE D-RING SLOT



POCKETS
2
INNER OUTER



FR RADIO
MIC TAB



BREATHABLE

WESTEX®
DH MATERIAL

8261FRHL

VEST, DUAL FR COMPLIANCE, CLASS 2, NFPA 2112, NFPA 70E, SOLID, HOOK & LOOP



DUAL
COMPLIANT

FR

NFPA 70E CAT 1

NFPA 2112

ATPV 6.6 CAL/CM²

ONE LESS VEST TO SPEC

Why buy two vests when one will do?
The GloWear 8261FRHL Vest offers dual FR compliance against flash fire and arc flash hazards, making ordering and replacing a breeze.



DUAL
COMPLIANT

8261FRHL

HI-VIS // FR CLASS 2 & 3



8263FRHL
 VEST, FR, CLASS 2, NFPA 70E,
 MESH, HOOK & LOOP, ECONOMY



8260FRHL
 VEST, FR, CLASS 2, NFPA 70E,
 MESH, HOOK & LOOP



8262FRZ
 VEST, FR, CLASS 2, NFPA 70E,
 SOLID FRONT, MESH BACK, ZIPPER,
 SURVEYOR



8356FRHL
 VEST, FR, CLASS 3, NFPA 70E,
 MESH, HOOK & LOOP

GLOWEAR® HI-VIS:

PUBLIC SAFETY CATEGORY

You're protecting and serving and, for that, we thank you. Let us help you stay safe and visible while you're doing it. Our GloWear Public Safety Vests are designed for public service pros like you. With features like radio tabs, 5-point breakaway and a custom logo program to make sure the streets know who you are—we've got you covered in the line of duty.

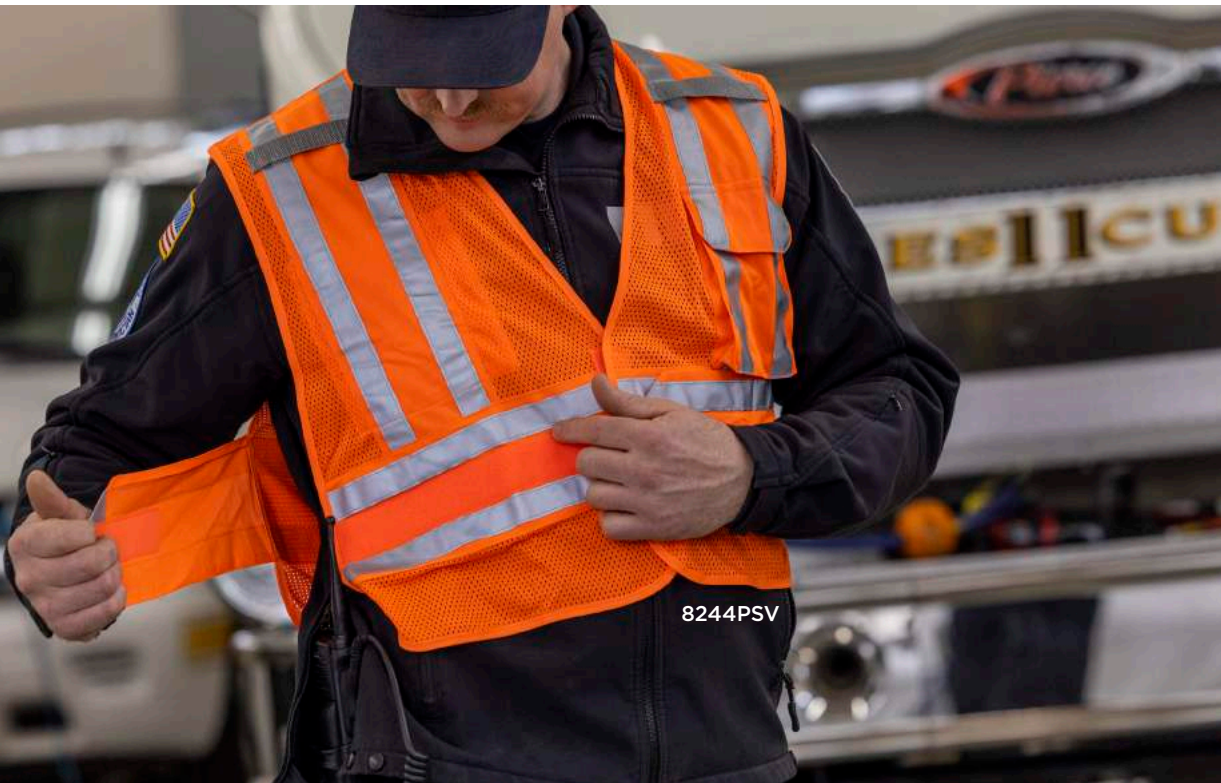

HI-VIS // PUBLIC SAFETY



8245PSV
VEST, TYPE P, CLASS 2



8244PSV
VEST, EXPANDABLE, TYPE P,
CLASS 2

SOMETIMES COMING UP SHORT IS A GOOD THING

Our public safety vests are designed with a shorter length for full and unobstructed access to your belt.

Plus, the added safety measure of hook-and-loop breakaway points at the shoulders and waist prevent dangerous hang ups.

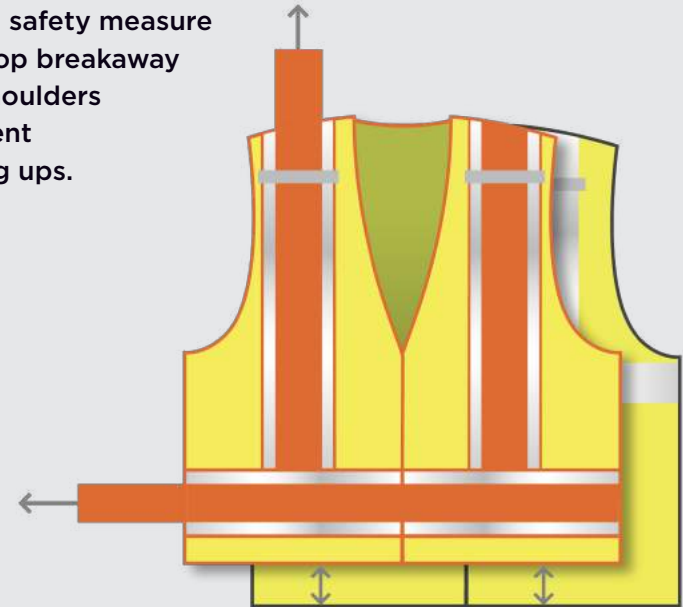

GLOWEAR® HI-VIS:

SHIRTS & SWEATSHIRTS CATEGORY

Our improved and expanded Hi-Vis Shirts & Sweatshirts Series lets tenacious SOB's from any trade comfortably enter another dimension of safety. No soppy soaked cotton here, just space-age fabric that scientifically sucks away moisture and hurls it back at the cosmos and toasty fleece that keeps you warm when the mercury drops. Be safely seen, get the sweat off your back and get more done. The cosmic trifecta—now available in long sleeve.



8283BK

T-SHIRT, LIGHTWEIGHT PERFORMANCE, TYPE R, CLASS 2, BLACK BOTTOM



8283BK PERFORMANCE MATERIAL IS 20% LIGHTER THAN 8280BK



HI-VIS // SHIRTS & SWEATSHIRTS



8280BK

T-SHIRT, PERFORMANCE, TYPE R, CLASS 2, BLACK BOTTOM



8289

T-SHIRT, TYPE R, CLASS 2



8289BK

T-SHIRT, TYPE R, CLASS 2, BLACK FRONT



8295

POLO T-SHIRT, TYPE R, CLASS 2



8089

T-SHIRT, NON-CERTIFIED



8091

LONG SLEEVE T-SHIRT, NON-CERTIFIED



8293

HOODED SWEATSHIRT, TYPE R, CLASS 2, BLACK BOTTOM



8372

ZIP UP SWEATSHIRT, HOODED, TYPE R, CLASS 3, BLACK BOTTOM



8373

HOODED SWEATSHIRT, TYPE R, CLASS 3, BLACK BOTTOM



8281BK

LONG SLEEVE T-SHIRT, PERFORMANCE, TYPE R, CLASS 2, BLACK BOTTOM



8291BK

LONG SLEEVE T-SHIRT, TYPE R, CLASS 2, BLACK BOTTOM



8391

LONG SLEEVE T-SHIRT, TYPE R, CLASS 3

GLOWEAR® HI-VIS:

THERMAL JACKETS CATEGORY

For workers who slug it out on Thunder Road in high-risk conditions, there's no better way to get year-round visibility and comfort than by wearing one of our 4-in-1 thermal or bomber safety jackets. The contagious, confident convergence of high-level visibility and versatility is designed to match wits with winter, spring or fall. With a weatherproof shell, toasty 3M™ Thinsulate™ insulation and reflective features galore, these jackets have enough firepower to make even the nastiest midnight run seem like a walk in the park.

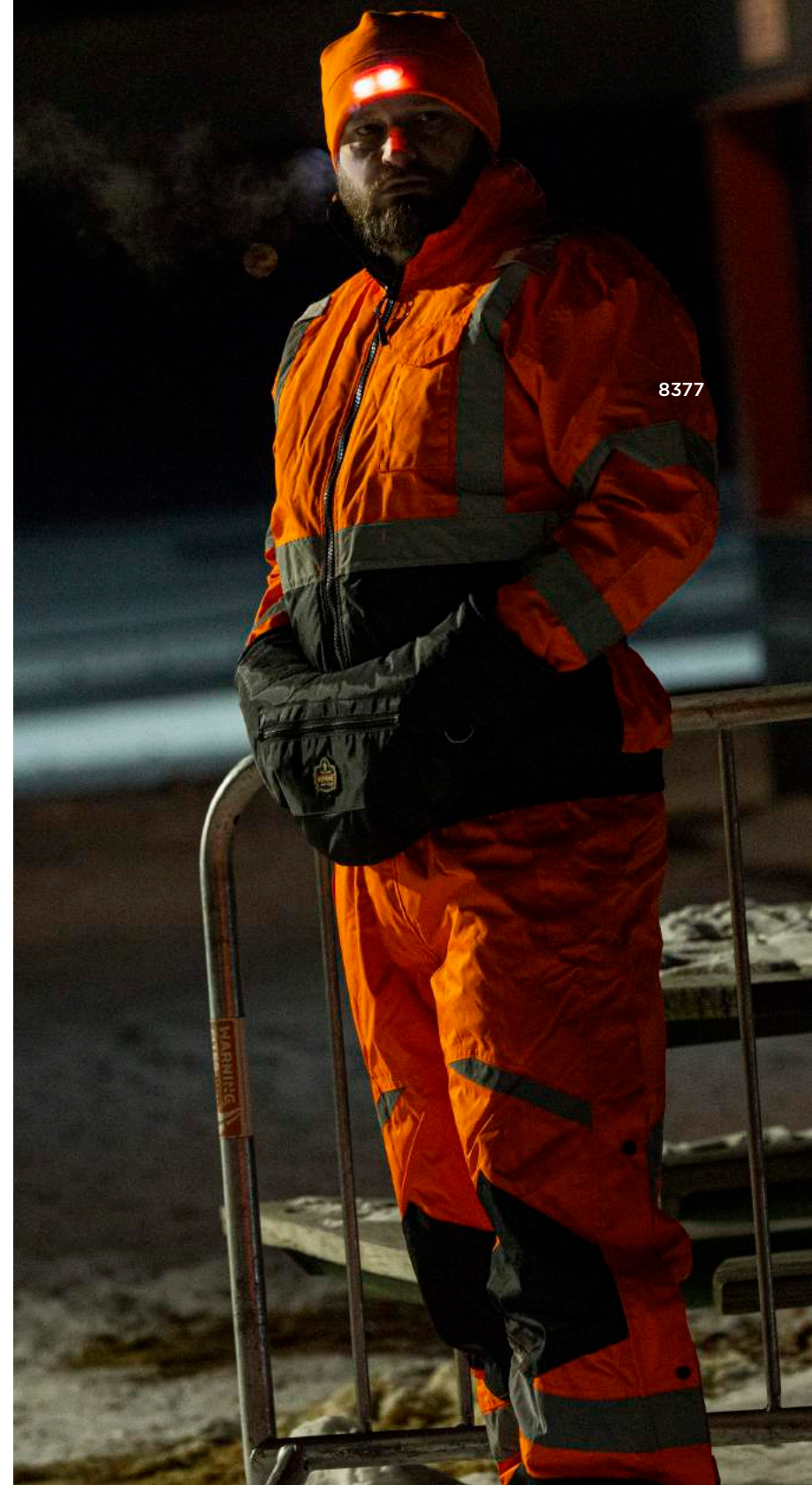



8351
WINDBREAKER WATER-RESISTANT
JACKET, TYPE R, CLASS 3



8353
SOFTSHELL WATER-RESISTANT
JACKET, TYPE R, CLASS 3



8287
THERMAL JACKET, TYPE R,
CLASS 2, REMOVABLE SLEEVES



8377
THERMAL JACKET, TYPE R,
CLASS 3, QUILTED BOMBER



8377EV
THERMAL JACKET, ENHANCED
VISIBILITY, NON-CERTIFIED,
QUILTED BOMBER



8379
THERMAL JACKET, TYPE R,
CLASS 3, FLEECE-LINED BOMBER



8381
THERMAL 4-IN-1 JACKET,
TYPE R, CLASS 3,
QUILTED-SLEEVES BOMBER



8384
THERMAL JACKET, TYPE R,
CLASS 3, QUILTED PARKA



8385
4-IN-1 JACKET, TYPE R, CLASS 3



8388
THERMAL 4-IN-1 JACKET, TYPE R, CLASS 3/2

WEATHERPROOF 300D OXFORD
POLYESTER OUTER SHELL WITH
BREATHABLE PU COATING

INNER JACKET WITH
100G 3M THINSULATE
AND ZIP OFF SLEEVES

- OUTER SHELL
INSET HOOD
- TWO EXTERNAL
FRONT POCKETS
- EXTERNAL ZIPPER
CHEST POCKET
- CELLPHONE
CHEST POCKET
- CLEAR ID BADGE
HOLDER
- DUAL MIC TABS

GLOWEAR® HI-VIS:

PANTS, BIBS & GAITERS CATEGORY

Shine like a dime in weatherproof perfection. With eye-catching reflective, Class 3 compliance (in combo with a Class 2 top), ANSI-compliant background materials and wide legs for quick on/off convenience, these mesh-lined marvels breathe new life into hi-vis comfort.



HI-VIS // PANTS, BIBS & GAITERS



8008
GAITERS, CLASS E



8009
GAITERS, TWO-TONE MESH,
CLASS E



8910
PANTS, CLASS E



8910BK
PANTS, TWO-TONE, CLASS E



8911
PANTS, TWO-TONE, CLASS E



8925
PANTS, THERMAL, CLASS E



8928
BIBS, WEATHERPROOF, INSULATED,
CLASS E



QUICK-RELEASE
SUSPENDER BUCKLES

COMFORTABLE
ELASTIC SIDES

PANT LEG ZIPPERS

QUICK SNAP
ZIPPER CLOSURES



GLOWEAR® HI-VIS:

HEADWEAR & ACCS. CATEGORY

Move over, Nadia Comaneci. When it comes to high-visibility extras, GloWear Accessories are a solid 10 on best-in-class brightness and versatility. From hi-vis hats to armbands and hard hat neck shades, these glowing add-ons complete the head-to-toe worker visibility demanded in the most challenging applications around. Give your people GloWear Headwear & Accessories and guarantee everyone in your entourage has a backstage pass to safety.

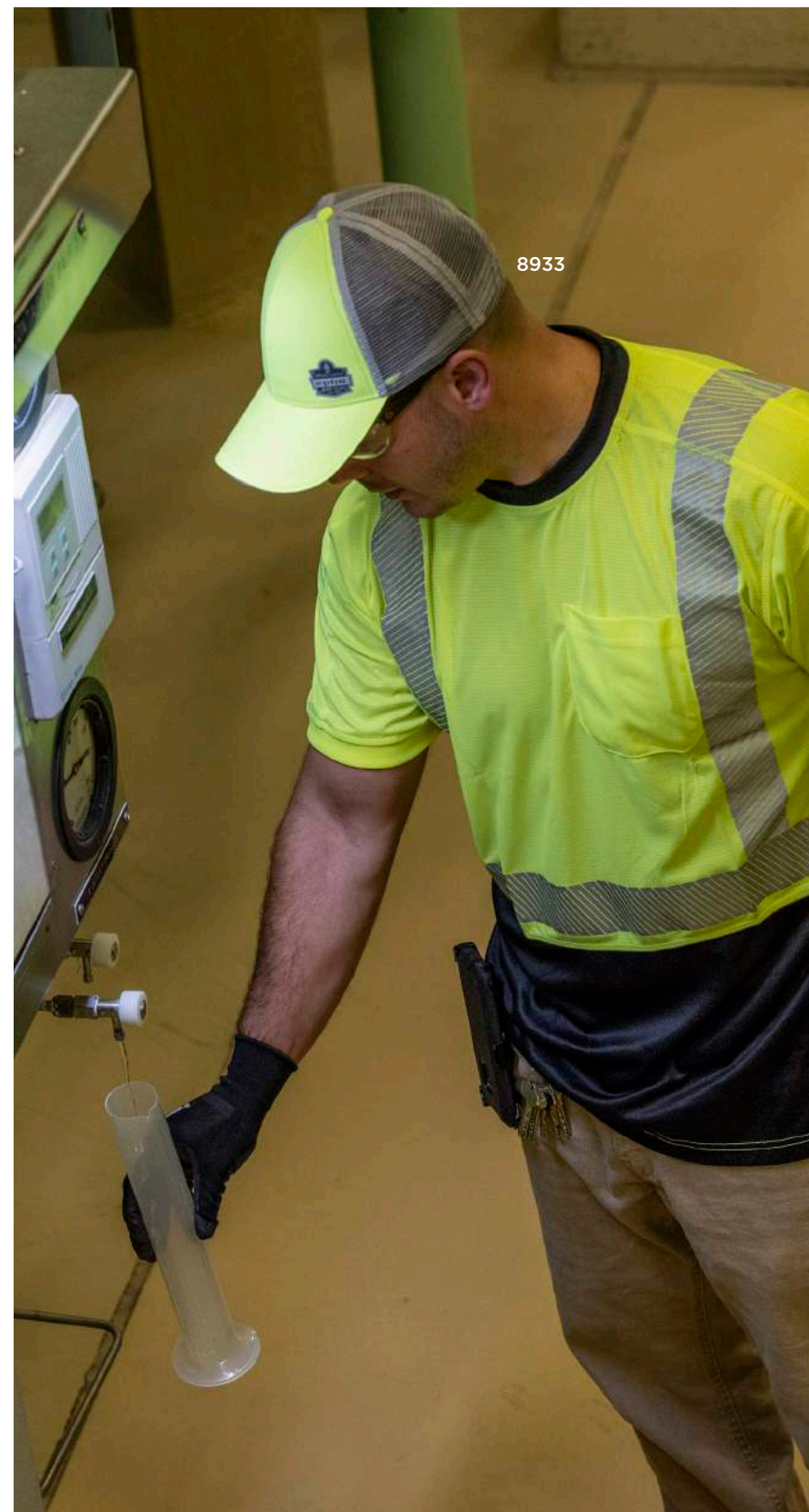

HI-VIS // HEADWEAR & ACCS.



8001
ARM AND LEG BAND,
SNAP CLOSURE



8004
SEAT BELT COVER



8005
NECK SHADE, MESH,
REFLECTIVE



8006
NECK SHADE, SOLID



8930
HAT, MESH VENTING PANELS



8931
HAT, REFLECTIVE, STRETCH-FIT



8933
HAT, REFLECTIVE, SNAPBACK



8935
RANGER SUN HAT, MESH VENTING



8935MF
RANGER SUN HAT, MESH VENTING,
MICROFIBER COOLING



8935CT
RANGER SUN HAT, MESH VENTING,
PVA COOLING



6487R
MULTI-BAND, REFLECTIVE,
COOLING



6660
BRIM AND NECK SHADE,
LIGHTWEIGHT, UNIVERSAL FIT



6650
HAT, HIGH-PERFORMANCE,
COOLING



6670CT
NECK SHADE, EVAPORATIVE
COOLING, PVA

GLOWEAR® HI-VIS:

RAIN GEAR CATEGORY

Rain, rain go away. Or don't. What do you care? After all, you're blazing brightly through the storm with ANSI-compliant high-visibility and weatherproof technology proven to shed rain of all varieties... Midnight, November, Purple or otherwise. With GloWear Hi-Vis Rainwear, rainy days may still get you down—but never for the count.



HI-VIS // RAIN GEAR



8365
RAIN JACKET, TYPE R, CLASS 3,
BREATHABLE



8365BK
RAIN JACKET, TYPE R, CLASS 3,
BLACK BOTTOM



8366
RAIN JACKET, LIGHTWEIGHT,
TYPE R, CLASS 3



8376K
RAIN JACKET & PANT SUIT,
LIGHTWEIGHT, TYPE R, CLASS 3



8385
4-IN-1 RAIN JACKET,
TYPE R, CLASS 3



8386
RAIN JACKET, TYPE R, CLASS 3,
OUTER SHELL



8915
RAIN PANTS, CLASS E,
BREATHABLE



8915BK
RAIN PANTS, CLASS E,
BLACK BOTTOM



8916
RAIN PANTS, LIGHTWEIGHT,
CLASS E











8918BK
RAIN BIBS, CLASS E,
BLACK BOTTOM









INDEX

CLASS 2 SERIES

CLASS 2, TYPE R MODELS

MODEL	HI-VIS ORANGE					HI-VIS LIME					
	XS	S/M	L/XL	2XL/3XL	4XL/5XL	XS	S/M	L/XL	2XL/3XL	4XL/5XL	
8205HL/Z SUPER ECONOMY POCKETS: 0 INNER: 0 OUTER: 0 REAR: 0											
	HL	20961	20963	20965	20967	20969	20971	20973	20975	20977	20979
	Z	—	20983	20985	20987	20989	—	20993	20995	20997	20999
FEATURES	<ul style="list-style-type: none"> • Hook & loop or zipper closure 										
8210HL/Z ECONOMY MESH POCKETS: 2 INNER: 1 OUTER: 1 REAR: 0											
	HL	21011	21013	21015	21017	21019	21021	21023	21025	21027	21029
	Z	—	21043	21045	21047	21049	—	21053	21055	21057	21059
FEATURES	<ul style="list-style-type: none"> • Inside: 1 large lower R pocket • Outside: Upper L chest mic tab 										
8215BA ECONOMY BREAKAWAY POCKETS: 1 INNER: 1 OUTER: 0 REAR: 0											
	HL	21061	21063	21065	21067	21069	21071	21073	21075	21077	21079
	Z	—	—	—	—	—	—	—	—	—	—
FEATURES	<ul style="list-style-type: none"> • Five-point hook & loop breakaway for added safety • Outside: Upper L chest mic tab 										
8216BA BREAKAWAY W/ID POCKETS: 2 INNER: 1 OUTER: 1 REAR: 0											
	HL	—	21083	21085	21087	21089	—	21093	21095	21097	21099
	Z	—	—	—	—	—	—	—	—	—	—
FEATURES	<ul style="list-style-type: none"> • Five-point hook & loop breakaway • Hook & loop front closure 					<ul style="list-style-type: none"> • Inside: 1 large lower R pocket • Outside: 1 clear ID pocket 					
8217BA BREAKAWAY POCKETS: 3 INNER: 2 OUTER: 1 REAR: 0											
	HL	—	—	—	—	—	—	21523	21525	21527	21529
	Z	—	—	—	—	—	—	—	—	—	—
FEATURES	<ul style="list-style-type: none"> • Five-point hook & loop breakaway • Hook & loop front closure 					<ul style="list-style-type: none"> • Inside: 1 lower L, 1 upper L • Outside: 1 lower R open-top 					
8220 HL/Z STANDARD MESH POCKETS: 3 INNER: 1 OUTER: 2 REAR: 0											
	HL	—	21133	21135	21137	21139	—	21143	21145	21147	21149
	Z	—	21113	21115	21117	21119	—	21123	21125	21127	21129
FEATURES	<ul style="list-style-type: none"> • Inside: 1 large lower R pocket • Outside: 2 lower XL pockets, 1 upper L mic tab 					<ul style="list-style-type: none"> • Hook & loop or zipper closure 					
8225HL/Z STANDARD SOLID POCKETS: 3 INNER: 1 OUTER: 2 REAR: 0											
	HL	—	21173	21175	21177	21179	—	21183	21185	21187	21189
	Z	—	21153	21155	21157	21159	—	21163	21165	21167	21169
FEATURES	<ul style="list-style-type: none"> • Inside: 1 large lower R pocket • Outside: 2 lower XL pockets, 1 upper L mic tab 					<ul style="list-style-type: none"> • Hook & loop or zipper closure 					
8229Z ECONO TWO-TONE MESH POCKETS: 1 INNER: 1 OUTER: 0 REAR: 0											
	HL	—	—	—	—	—	—	—	—	—	—
	Z	21301	21303	21305	21307	21309	21291	21293	21295	21297	21299
FEATURES	<ul style="list-style-type: none"> • Reflective set on 3.5" contrasting background • Inside: 1 large lower L pocket 					<ul style="list-style-type: none"> • Outside: 1 upper L mic tab • Zipper closure 					

CLASS 2, TYPE R MODELS

MODEL	HI-VIS ORANGE					HI-VIS LIME						
	XS	S/M	L/XL	2XL/3XL	4XL/5XL	XS	S/M	L/XL	2XL/3XL	4XL/5XL		
8230Z TWO-TONE MESH POCKETS: 1 INNER: 1 OUTER: 0 REAR: 0		HL	—	—	—	—	—	—	—	—		
		Z	—	21313	21315	21317	21319	—	21323	21325	21327	21329
		FEATURES	<ul style="list-style-type: none"> • 3M™ Scotchlite™ Reflective Material • Reflective set on 3.5" contrasting background 					<ul style="list-style-type: none"> • Inside: 1 large lower L pocket • Outside: Upper L chest mic tab 				
8235ZX TWO-TONE X BACK POCKETS: 5 INNER: 1 OUTER: 4 REAR: 0		HL	—	—	—	—	—	—	—	—		
		Z	—	26183	26185	26187	26189	—	—	—	—	
		FEATURES	<ul style="list-style-type: none"> • X-back reflective; D-ring access slot • Reflective set on 3.5" contrasting background 					<ul style="list-style-type: none"> • Inside: 1 large lower L pocket • Outside Upper: L cell pocket, R 3 slot pen pocket 				
8246Z TWO-TONE MESH POCKETS: 6 INNER: 2 OUTER: 4 REAR: 0		HL	—	—	—	—	—	—	—	—		
		Z	—	24133	24135	24137	24139	—	24143	24145	24147	24149
		FEATURES	<ul style="list-style-type: none"> • Reflective binding trim • Inside: 2 large lower pockets 					<ul style="list-style-type: none"> • Outside Upper L: 1 cell phone & ID pocket, mic tab • Outside Upper R: 1 dual layer pen & open 				
8248Z TWO-TONE SURVEYORS POCKETS: 6 INNER: 2 OUTER: 4 REAR: 0		HL	—	—	—	—	—	—	—	—		
		Z	—	24063	24065	24067	24069	—	24073	24075	24077	24079
		FEATURES	<ul style="list-style-type: none"> • Solid front / mesh back • Inside: 2 large lower pockets 					<ul style="list-style-type: none"> • Outside Upper L: 1 cell phone, mic tab • Outside Upper R: 1 dual layer pen & open top 				
8249Z ECONOMY SURVEYORS POCKETS: 4 INNER: 2 OUTER: 2 REAR: 0		HL	—	—	—	—	—	—	—	—		
		Z	24011	24013	24015	24017	24019	24021	24023	24025	24027	24029
		FEATURES	<ul style="list-style-type: none"> • Solid front / mesh back • Inside: 2 large lower pockets 					<ul style="list-style-type: none"> • Outside Upper L: 1 cell phone, mic tab • Outside Upper R: 1 dual layer pen & open top 				
8250Z SURVEYORS POCKETS: 7 INNER: 2 OUTER: 4 REAR: 1		HL	—	—	—	—	—	—	—	—		
		Z	—	21413	21415	21417	21419	—	21423	21425	21427	21429
		FEATURES	<ul style="list-style-type: none"> • Solid front / mesh back • Inside: 2 large lower pockets 					<ul style="list-style-type: none"> • Outside Upper L: 1 cell phone, mic tab • Outside Upper R: 1 dual layer pen & open top 				
8250ZHG COMBINED PERFORMANCE TAPE SURVEYORS POCKETS: 7 INNER: 2 OUTER: 4 REAR: 1		HL	—	—	—	—	—	—	—	—		
		Z	—	21433	21435	21437	21439	—	—	—	—	
		FEATURES	<ul style="list-style-type: none"> • Solid front / mesh back • Inside: 2 large lower pockets 					<ul style="list-style-type: none"> • Outside Upper L: 1 cell phone, mic tab • Outside Upper R: 1 dual layer pen & open top 				
8253HDZ HD MESH SURVEYORS POCKETS: 7 INNER: 2 OUTER: 4 REAR: 1		HL	—	—	—	—	—	—	—	—		
		Z	—	23313	23315	23317	23319	—	23323	23325	23327	23329
		FEATURES	<ul style="list-style-type: none"> • Lanyard grommet holds, structured webbing • Inside: 2 large lower pockets 					<ul style="list-style-type: none"> • Outside Upper L: 1 cell phone, mic tab • Outside Upper R: 1 dual layer pen & open top 				

INDEX

CLASS 2 SERIES

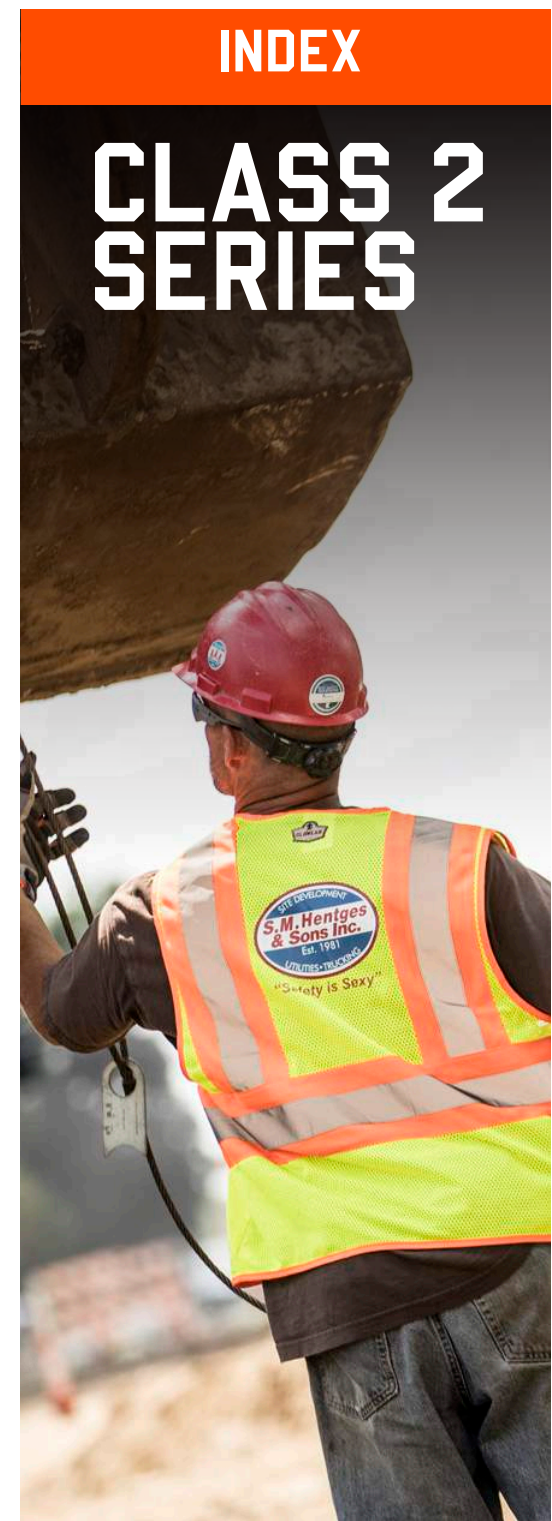

CLASS 2 SERIES



		HI-VIS ORANGE				
MODEL		XS	S/M	L/XL	2XL/3XL	4XL/5XL
8260FRHL MESH POCKETS: 2 INNER: 2 OUTER: 0 REAR: 0	HL	—	—	—	—	—
	Z	—	—	—	—	—
	FEATURES	<ul style="list-style-type: none"> • 87% Modacrylic & 13% Kevlar Material • NFPA 70E, ASTM F1506; ATPV of 4.6 cal/cm² 				
8261FRHL SOLID POCKETS: 2 INNER: 2 OUTER: 0 REAR: 0	HL	—	—	—	—	—
	Z	—	—	—	—	—
	FEATURES	<ul style="list-style-type: none"> • 48% Tencel, 40% Modacrylic, 12% Para-aramid • NFPA 2112 & NFPA 70E, ATPV of 6.6 cal/cm² 				
8262FRZ SOLID FRONT, MESH BACK POCKETS: 4 INNER: 0 OUTER: 4 REAR: 0	HL	—	—	—	—	—
	Z	—	—	—	—	—
	FEATURES	<ul style="list-style-type: none"> • Solid Front: 48% Tencel, 40% Modacrylic, 12% Para-aramid • Mesh Back: 87% Modacrylic, 13% Kevlar 				
8263FRHL ECONOMY MESH POCKETS: 2 INNER: 2 OUTER: 0 REAR: 0	HL	—	—	—	—	—
	Z	—	—	—	—	—
	FEATURES	<ul style="list-style-type: none"> • 60% modacrylic mesh & 40% cotton • NFPA 70E CAT 1, ASTM F1506; ATPV of 5.1 cal/cm² 				

		HI-VIS LIME				
MODEL		XS	S/M	L/XL	2XL/3XL	4XL/5XL
	HL	—	21493	21495	21497	21499
	Z	—	—	—	—	—
	FEATURES	<ul style="list-style-type: none"> • 3M™ Scotchlite™ FR Reflective Tape • Inside: 1 lower R inside pocket, 1 L chest pen pocket 				
	HL	—	21463	21465	21467	21469
	Z	—	—	—	—	—
	FEATURES	<ul style="list-style-type: none"> • 3M™ Scotchlite™ FR Reflective Tape • Inside: 1 lower, 1 dual layer pen 				
	HL	—	—	—	—	—
	Z	—	21483	21485	21487	21489
	FEATURES	<ul style="list-style-type: none"> • Front: NFPA 70E, ATPV 6.6 cal/cm²; Back: NFPA 70E, ATPV 4.6 cal/cm² • Outside: 2 lower open top, 1 dual-layer pen, 1 cell phone, mic tab 				
	HL	—	21863	21865	21867	21869
	Z	—	—	—	—	—
	FEATURES	<ul style="list-style-type: none"> • 2" FR reflective tape for low-light visibility 				

TETHERING MODELS

		S/M	L/XL	2XL/3XL	4XL/5XL	6XL/7XL
8231TV TOOL TETHERING POCKETS: 5 INNER: 1 OUTER: 4 REAR: 0	HL	—	—	—	—	—
	Z	—	—	—	—	—
	FEATURES	<ul style="list-style-type: none"> • ANSI/ISEA 121 & 107 certified for dropped object prevention & hi-vis compliance, 20& ANSI 121-certified tethering points 				

S/M	L/XL	2XL/3XL	4XL/5XL	6XL/7XL
24173	24175	24177	24179	—
<ul style="list-style-type: none"> • D-ring slot for wear over fall harness • Outside: 2 lower, 2 chest for retractable lanyard 				

PUBLIC SAFETY, TYPE P MODELS

		S/M	L/XL	2XL/3XL	4XL/5XL	6XL/7XL
8245PSV PUBLIC SAFETY POCKETS: 1 INNER: 1 OUTER: 0 REAR: 0	HL	23383	23385	23387	23389	23390
	Z	—	—	—	—	—
	FEATURES	<ul style="list-style-type: none"> • Solid front / mesh back • Five-point hook & loop breakaway 				

S/M	L/XL	2XL/3XL	4XL/5XL	6XL/7XL
23393	23395	23397	23399	24000
<ul style="list-style-type: none"> • 3M™ Scotchlite™ Reflective Material • Inside: Upper L dual layer 4 pen & open top pocket 				

		M/L	XL/2XL	3XL&		
8244PSV PUBLIC SAFETY POCKETS: 2 INNER: 1 OUTER: 1 REAR: 0	HL	21360	21362	21363	—	—
	Z	—	—	—	—	—
	FEATURES	<ul style="list-style-type: none"> • Expandable adjustable waistband for a precise fit • Reflective set on 4.5" contrasting background 				





M/L	XL/2XL	3XL&		
21364	21366	21367	—	—
<ul style="list-style-type: none"> • 3M™ Scotchlite™ Reflective Material • Inside: Upper L dual layer 4 pen & open top pocket 				

INDEX



CLASS 3 & CLASS E SERIES





CLASS 3 MODELS

MODEL	HI-VIS ORANGE					HI-VIS LIME					
	XS	S/M	L/XL	2XL/3XL	4XL/5XL	XS	S/M	L/XL	2XL/3XL	4XL/5XL	
8310HL ECONOMY MESH POCKETS: 1 INNER: 1 OUTER: 0 REAR: 0											
	HL	—	22013	22015	22017	22019	—	22023	22025	22027	22029
	Z	—	—	—	—	—	—	—	—	—	—
FEATURES	<ul style="list-style-type: none"> • Hook & loop front closure • Inside: 1 large lower pocket 										
8320Z STANDARD MESH POCKETS: 3 INNER: 1 OUTER: 2 REAR: 0											
	HL	—	—	—	—	—	—	—	—	—	—
	Z	—	22113	22115	22117	22119	—	22123	22125	22127	22129
FEATURES	<ul style="list-style-type: none"> • Zipper closure • Inside: 1 large lower R pocket 										
8330Z TWO-TONE MESH POCKETS: 1 INNER: 1 OUTER: 0 REAR: 0											
	HL	—	—	—	—	—	—	—	—	—	—
	Z	—	22173	22175	22177	22179	—	22183	22185	22187	22189
FEATURES	<ul style="list-style-type: none"> • Reflective set on 3.5" contrasting background • Zipper closure 										
8346Z TWO-TONE SURVEYOR POCKETS: 6 INNER: 2 OUTER: 4 REAR: 0											
	HL	—	—	—	—	—	—	—	—	—	—
	Z	—	24153	24155	24157	24159	—	24163	24165	24167	24169
FEATURES	<ul style="list-style-type: none"> • Reflective binding trim • Inside: 2 large lower pockets 										
8356FRHL MODACRYLIC MESH POCKETS: 2 INNER: 2 OUTER: 0 REAR: 0											
	HL	—	—	—	—	—	—	22213	22215	22217	22219
	Z	—	—	—	—	—	—	—	—	—	—
FEATURES	<ul style="list-style-type: none"> • 87% Modacrylic & 13% Kevlar Material • NFPA 70E Cat 1, ASTM F1506; ATPV of 4.6 cal/cm² 										

CLASS E SERIES

8910 POCKETS: 1 INNER: 0 OUTER: 1 REAR: 0											
	HL	—	22853	22855	22857	22859	—	22953	22955	22957	22959
	Z	—	—	—	—	—	—	—	—	—	—
FEATURES	<ul style="list-style-type: none"> • Polyester mesh • Drawstring waist, R leg cargo pocket 										
8910BK BLK. POCKETS: 1 INNER: 0 OUTER: 0 REAR: 0											
	HL	—	—	—	—	—	—	23953	23955	23957	23959
	Z	—	—	—	—	—	—	—	—	—	—
FEATURES	<ul style="list-style-type: none"> • Polyester mesh • Drawstring waist, R leg cargo pocket 										

CLASS 3 & CLASS E SERIES

MODEL	HI-VIS ORANGE					HI-VIS LIME						
	XS	S/M	L/XL	2XL/3XL	4XL/5XL	XS	S/M	L/XL	2XL/3XL	4XL/5XL		
8911 TWO-TONE POCKETS: 1 INNER: 0 OUTER: 1 REAR: 0		HL	—	22863	22865	22867	22869	—	22963	22965	22967	22969
		Z	—	—	—	—	—	—	—	—	—	—
		FEATURES	<ul style="list-style-type: none"> • Polyester mesh • Reflective set on 4.5" contrasting background 					<ul style="list-style-type: none"> • Drawstring waist, R leg cargo pocket • Wide leg openings with hook & loop closures 				
8008 POCKETS: 0 INNER: 0 OUTER: 0 REAR: 0		HL	OSFA: 29081					OSFA: 29083				
		Z	—	—	—	—	—	—	—	—	—	—
		FEATURES	<ul style="list-style-type: none"> • Weatherproof polyester shell with PU coating • Drawstring closures on top and bottom 									
8009 MESH POCKETS: 0 INNER: 0 OUTER: 0 REAR: 0		HL	OSFA: 29091					OSFA: 29093				
		Z	—	—	—	—	—	—	—	—	—	—
		FEATURES	<ul style="list-style-type: none"> • Polyester mesh • Drawstring closures on top and bottom 									



MEET BOB. INVENTOR OF HI-VIS.

One day at work, a man named Bob (we'll get to that wedding dress in a second) knocked himself silly and he slipped into a coma. Eventually he snapped out of it, but his doc told him to lay low in a dark room as he recovered. Naturally Bob passed the time by playing around with fluorescent materials and mixing them with wood varnish in his family's bathtub (as you do). Voila! The world's first fluorescent paint.

Somehow the U.S. Army caught wind of Bob's bathtub experiments and asked him to mix this new paint with fabric to help protect troops from friendly fire. Perhaps still not thinking clearly after the accident, Bob decided to experiment with his wife's wedding dress. Questionable judgement, but successful results. It actually worked. Way to go, Bob.

And that friend, is the totally amazing true story of how a wedding dress became the worlds first piece of hi-vis clothing, and the ancestor of our now extensive line of GloWear® Hi-Vis Apparel -- as impossible to ignore on the jobsite as our guy Bob in a wedding dress.

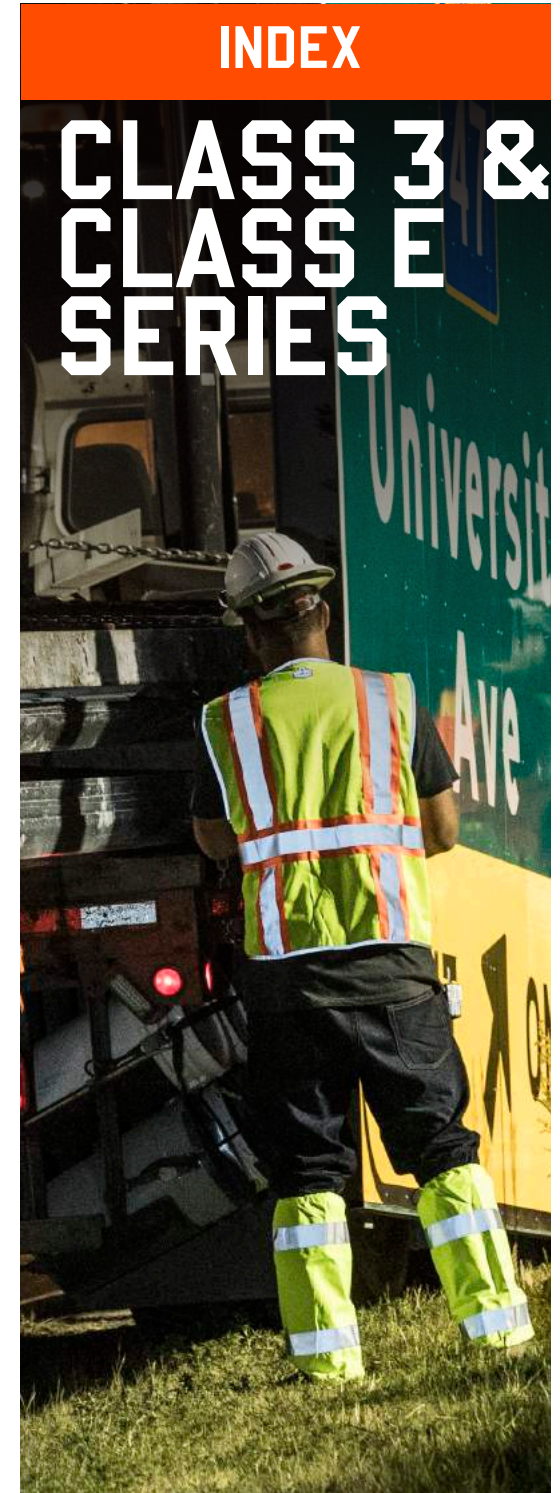

INDEX



SHIRT SERIES

SHIRT MODELS

MODEL		XS	S	M	L	XL	2XL	3XL	4XL	5XL	
8089 NON-CERT T		ORANGE	—	21562	21563	21564	21565	21566	21567	21568	21569
		LIME	—	21552	21553	21554	21555	21556	21557	21558	21559
		FEATURES	<ul style="list-style-type: none"> • Polyester breathable knit • Moisture-wicking treatment • Outside Upper L chest pocket 								
8091 NON-CERT L/S T		ORANGE	—	21592	21593	21594	21595	21596	21597	21598	21599
		LIME	—	21582	21583	21584	21585	21586	21587	21588	21589
		FEATURES	<ul style="list-style-type: none"> • Polyester breathable knit • Moisture-wicking treatment • Outside Upper L chest pocket 								
8280BK CLASS 2 BLK. FRONT T		ORANGE	—	22582	22583	22584	22585	22586	22587	22588	22589
		LIME	—	22532	22533	22534	22535	22536	22537	22538	22539
		FEATURES	<ul style="list-style-type: none"> • Polyester breathable knit, moisture-wicking treatment • 3M™ Scotchlite™ Comfort Trim (75 washes) • Outside Upper L chest pocket • STANDARD 100 by OEKO-TEX® certified 								
8281BK CLASS 2 BLK. FRONT L/S T		ORANGE	—	22682	22683	22684	22685	22686	22687	22688	22689
		LIME	—	22632	22633	22634	22635	22636	22637	22638	22639
		FEATURES	<ul style="list-style-type: none"> • Polyester breathable knit • 3M™ Scotchlite™ Comfort Trim (75 washes) • Moisture-wicking treatment • Outside Upper L chest pocket 								
8289 CLASS 2 T		ORANGE	21511	21512	21513	21514	21515	21516	21517	21518	21519
		LIME	21501	21502	21503	21504	21505	21506	21507	21508	21509
		FEATURES	<ul style="list-style-type: none"> • Polyester breathable knit • Heat transfer reflective • Moisture-wicking treatment • Outside Upper L chest pocket 								
8289BK CLASS 2 BLK. FRONT T		ORANGE	—	22512	22513	22514	22515	22516	22517	22518	22519
		LIME	—	22502	22503	22504	22505	22506	22507	22508	22509
		FEATURES	<ul style="list-style-type: none"> • Polyester breathable knit • Heat transfer reflective • Moisture-wicking treatment • Outside Upper L chest pocket 								
8291BK CLASS 2 BLK. FRONT L/S T		ORANGE	—	22712	22713	22714	22715	22716	22717	22718	22719
		LIME	—	22702	22703	22704	22705	22706	22707	22708	22709
		FEATURES	<ul style="list-style-type: none"> • Polyester breathable knit • Heat transfer reflective • Moisture-wicking treatment • Outside Upper L chest pocket 								



SHIRT SERIES



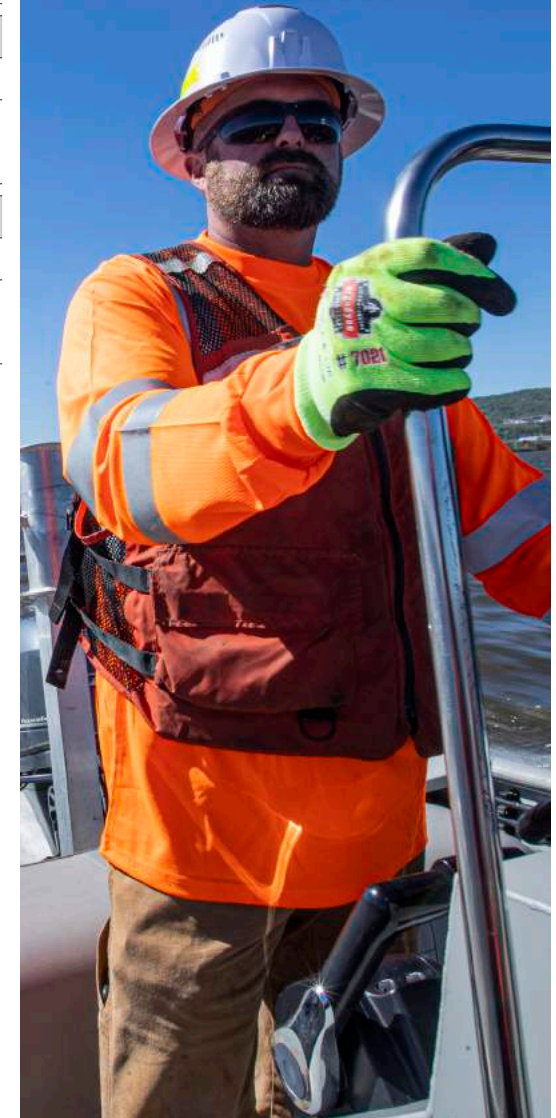

MODEL		XS	S	M	L	XL	2XL	3XL	4XL	5XL	
8295 CLASS 2 POLO POCKETS: 1 INNER: 0 OUTER: 1 REAR: 0		ORANGE	—	—	—	—	—	—	—	—	
		LIME	—	21642	21643	21644	21645	21646	21647	21648	21649
		FEATURES	<ul style="list-style-type: none"> • Polyester breathable knit • Heat transfer reflective 				<ul style="list-style-type: none"> • Moisture-wicking treatment • Split tail hem 				
8391 CLASS 3 L/S T POCKETS: 1 INNER: 0 OUTER: 1 REAR: 0		ORANGE	—	21712	21713	21714	21715	21716	21717	21718	21719
		LIME	—	21702	21703	21704	21705	21706	21707	21708	21709
		FEATURES	<ul style="list-style-type: none"> • Polyester breathable knit • Heat transfer reflective 				<ul style="list-style-type: none"> • Moisture-wicking treatment 				
8283BK CLASS 2 PERFORMANCE T POCKETS: 1 INNER: 0 OUTER: 1 REAR: 0		ORANGE	—	23512	23513	23514	23515	23516	23517	23518	23519
		LIME	—	23502	23503	23504	23505	23506	23507	23508	23509
		FEATURES	<ul style="list-style-type: none"> • Polyester breathable knit, moisture-wicking treatment • 3M™ Scotchlite™ Comfort Trim (75 washes) 				<ul style="list-style-type: none"> • Underarm vents • STANDARD 100 by OEKO-TEX® certified 				



INDEX



CLASS 1 & NON-CERT SERIES

CLASS 1 & NON-CERTIFIED MODELS

MODEL		OS				
8010HL ECONOMY		ORANGE	20010			
		LIME	20020			
POCKETS: 0 INNER: 0 OUTER: 0 REAR: 0		FEATURES	<ul style="list-style-type: none"> • Polyester mesh • Hook & loop closure 			
8020HL STANDARD		ORANGE	20030			
		LIME	20040			
POCKETS: 0 INNER: 0 OUTER: 0 REAR: 0		FEATURES	<ul style="list-style-type: none"> • Polyester mesh • Hook & loop closure 			
8040HL COMBINED PERFORMANCE TAPE		ORANGE	20070			
		LIME	20080			
POCKETS: 0 INNER: 0 OUTER: 0 REAR: 0		FEATURES	<ul style="list-style-type: none"> • Polyester mesh • Hook & loop closure • 1" combined performance reflective tape 			
8080BAX X-BACK		ORANGE	26030			
		LIME	26040			
POCKETS: 0 INNER: 0 OUTER: 0 REAR: 0		FEATURES	<ul style="list-style-type: none"> • Polyester mesh • Hook & loop closure • 2" combined performance reflective tape • Breakaway shoulders & X-back design 			
MODEL		XS/S	M/L	XL/2XL	3XL &	
8140BA TYPE 0 BREAKAWAY		ORANGE	—	27017	27018	27019
		LIME	—	27014	27015	27016
POCKETS: 1 INNER: 0 OUTER: 1 REAR: 0		FEATURES	<ul style="list-style-type: none"> • Oxford polyester • 3M™ Scotchlite™ Reflective • X-back design • Breakaway shoulders and sides 			



SWEATSHIRT MODELS

MODEL		XS	S	M	L	XL	2XL	3XL	4XL	5XL	
8293 TYPE R CLASS 2 POCKETS: 1 INNER: 0 OUTER: 1 REAR: 0		ORANGE	—	—	—	—	—	—	—	—	
		LIME	—	21682	21683	21684	21685	21686	21687	21688	21689
		FEATURES	<ul style="list-style-type: none"> • Polyester fleece • Heat transfer reflective • Black panels hide dirt & wear • Drawstring hood & pouch style pocket 								
8372 TYPE R CLASS 3 FRONT ZIP POCKETS: 2 INNER: 0 OUTER: 2 REAR: 0		ORANGE	—	—	—	—	—	—	—	—	
		LIME	—	—	21843	21844	21845	21846	21847	21848	21849
		FEATURES	<ul style="list-style-type: none"> • Polyester polar fleece • Drawstring hood • Black panels hide dirt & wear • Slash style pockets 								
8373 TYPE R CLASS 3 POCKETS: 1 INNER: 0 OUTER: 1 REAR: 0		ORANGE	—	—	—	—	—	—	—	—	
		LIME	—	—	21883	21884	21885	21886	21887	21888	21889
		FEATURES	<ul style="list-style-type: none"> • Polyester polar fleece • Drawstring hood • Black panels hide dirt & wear • Pouch style pocket 								

INDEX



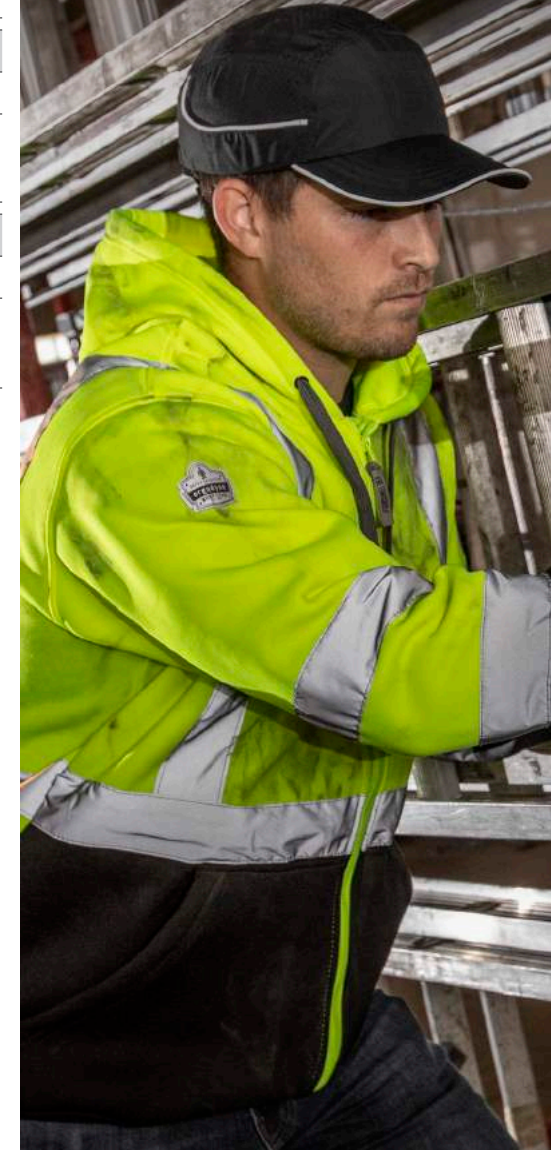



SWEATSHIRT SERIES



INDEX







THERMAL JACKET SERIES

THERMAL JACKET MODELS

MODEL		XS	S	M	L	XL	2XL	3XL	4XL	5XL	
8377 TYPE R CLASS 3 QUILTED POCKETS: 4 INNER: 1 OUTER: 3 REAR: 0		ORANGE	—	25612	25613	25614	25615	25616	25617	25618	25619
		LIME	—	25622	25623	25624	25625	25626	25627	25628	25629
	FEATURES	<ul style="list-style-type: none"> Weatherproof 300D oxford polyester shell PU coating 	<ul style="list-style-type: none"> Fully lined with 160g thermal quilted insulation Black panels hide dirt & wear 								
8377EV NON-CERTIFIED QUILTED BOMBER POCKETS: 4 INNER: 0 OUTER: 4 REAR: 0		BLACK	—	25642	25643	25644	25645	25646	25647	25648	25649
	FEATURES	<ul style="list-style-type: none"> Weatherproof 300D oxford polyester shell PU coating 	<ul style="list-style-type: none"> 160g quilted insulation for warmth without extra bulk Adjustable inset hood with drawstring 								
	8379 TYPE R CLASS 3 FLEECE LINED BOMBER POCKETS: 4 INNER: 1 OUTER: 3 REAR: 0		ORANGE	—	24462	24463	24464	24465	24466	24467	24468
		LIME	—	24472	24473	24474	24475	24476	24477	24478	24479
FEATURES		<ul style="list-style-type: none"> Weatherproof 300D oxford polyester shell PU coating 	<ul style="list-style-type: none"> Zip-out 220g microfleece liner Black accents on high wear areas 								
8381 TYPE R CLASS 3 4-IN-1 POCKETS: 6 INNER: 2 OUTER: 4 REAR: 0		ORANGE	—	25582	25583	25584	25585	25586	25587	25588	25589
		LIME	—	25592	25593	25594	25595	25596	25597	25598	25599
	FEATURES	<ul style="list-style-type: none"> Weatherproof 300D performance ripstop polyester shell Breathable PU coating 	<ul style="list-style-type: none"> 280g fleece body & thermal insulated quilted sleeves Zip-out liner with zip-off sleeves creates fleece vest 								
8287 TYPE R CLASS 3 PERFORMANCE THERMAL POCKETS: 2 INNER: 0 OUTER: 2 REAR: 0		ORANGE	—	25512	25513	25514	25515	25516	25517	25518	25519
		LIME	—	25492	25493	25494	25495	25496	25497	25498	25499
	FEATURES	<ul style="list-style-type: none"> Wear as a jacket, vest or ultra-warm winter parka Breathable 300D oxford polyester shell with PU coating 	<ul style="list-style-type: none"> 100g 3M™ Thinsulate™ body insulation 2" ANSI-compliant 3M™ Scotchlite™ Reflective 								
8386 TYPE R CLASS 3 PERFORMANCE SHELL POCKETS: 6 INNER: 2 OUTER: 4 REAR: 0		ORANGE	—	25462	25463	25464	25465	25466	25467	25468	25469
		LIME	—	25372	25373	25374	25375	25376	25377	25378	25379
	FEATURES	<ul style="list-style-type: none"> Weatherproof 300D oxford polyester shell Breathable PU coating with polyester mesh lining 	<ul style="list-style-type: none"> 2" ANSI-compliant 3M™ Scotchlite™ Reflective Black panels hide dirt and wear 								
8388 TYPE R CLASS 3 4-IN-1 POCKETS: 2 INNER: 0 OUTER: 2 REAR: 0	 8386 + 8287	ORANGE	—	25552	25553	25554	25555	25556	25557	25558	25559
		LIME	—	25532	25533	25534	25535	25536	25537	25538	25539
	FEATURES	<ul style="list-style-type: none"> Weatherproof 300D oxford polyester shell (8386) STANDARD 100 by OEKO-TEX® certified 	<ul style="list-style-type: none"> 100g 3M™ Thinsulate™ body insulation with 80g sleeve insulation (8287) & 3M™ Scotchlite™ Reflective 								



THERMAL JACKET SERIES

MODEL		XS	S	M	L	XL	2XL	3XL	4XL	5XL	
8384 TYPE R CLASS 3 THERMAL PARKA POCKETS: 3 INNER: 0 OUTER: 3 REAR: 0		ORANGE	—	25572	25573	25574	25575	25576	25577	25578	25579
		LIME	—	25562	25563	25564	25565	25566	25567	25568	25569
	FEATURES	<ul style="list-style-type: none"> Weatherproof 300D oxford polyester shell 160g thermal quilted insulation & fleece lining 		<ul style="list-style-type: none"> Inset hood with drawstring and stoppers Storm flap front with snap closure 							
8385 TYPE R CLASS 3 4-IN-1 POCKETS: 5 INNER: 2 OUTER: 3 REAR: 0		ORANGE	—	24372	24373	24374	24375	24376	24377	24378	24379
		LIME	—	24382	24383	24384	24385	24386	24387	24388	24389
	FEATURES	<ul style="list-style-type: none"> Weatherproof 300D oxford polyester shell Breathable PU coating 		<ul style="list-style-type: none"> Inner jacket with 100g 3M™ Thinsulate™ lining 3M™ Scotchlite™ Reflective Material 							
8928 CLASS E THERMAL POCKETS: 3 INNER: 0 OUTER: 3 REAR: 0		ORANGE	—	—	—	—	—	—	—	—	
		LIME	—	25522	25523	25524	25525	25526	25527	25528	25529
	FEATURES	<ul style="list-style-type: none"> Weatherproof 300D oxford polyester shell Breathable PU coatings; 160g quilted insulation 		<ul style="list-style-type: none"> Adjustable elastic suspenders Zippered chest and side pockets 							
8925 CLASS E THERMAL POCKETS: 6 INNER: 2 OUTER: 4 REAR: 0		ORANGE	—	24442	24443	24444	24445	24446	24447	24448	24449
		LIME	—	24452	24453	24454	24455	24456	24457	24458	24459
	FEATURES	<ul style="list-style-type: none"> Weatherproof 300D oxford polyester shell Breathable PU coating 		<ul style="list-style-type: none"> 80g 3M™ Thinsulate™ lining 3M™ Scotchlite™ Reflective Material 							
8351 TYPE R CLASS 3 THERMAL PARKA POCKETS: 3 INNER: 0 OUTER: 3 REAR: 0		ORANGE	—	—	—	—	—	—	—	—	
		LIME	—	23522	23523	23524	23525	23526	23527	23528	23529
	FEATURES	<ul style="list-style-type: none"> Wind- and water- resistant PU coating Lightweight polyester sipstop fabric 		<ul style="list-style-type: none"> Microfleece fleece interior 2" reflective tape 							
8353 TYPE R CLASS 3 4-IN-1 POCKETS: 5 INNER: 2 OUTER: 3 REAR: 0		LIME	—	23522	23523	23524	23525	23526	23527	23528	23529
		FEATURES	<ul style="list-style-type: none"> Wind- and water- resistant PU coating Lightweight polyester performance fabric 		<ul style="list-style-type: none"> Polar fleece interior 2" reflective tape 						











INDEX









RAINWEAR SERIES



RAINWEAR MODELS

MODEL		XS	S	M	L	XL	2XL	3XL	4XL	5XL	
8365BK TYPE R CLASS 3 BLACK FRONT		ORANGE	—	—	—	—	—	—	—	—	
		LIME	—	25322	25323	25324	25325	25326	25327	25328	25329
	POCKETS: 3 INNER: 0 OUTER: 3 REAR: 0	FEATURES	<ul style="list-style-type: none"> Weatherproof 300D oxford polyester shell Breathable PU coating, polyester mesh lining 				<ul style="list-style-type: none"> 3M™ Scotchlite™ Reflective Material Black panels hide dirt & wear 				
8365 TYPE R CLASS 3 RAIN		ORANGE	—	24312	24313	24314	24315	24316	24317	24318	24319
		LIME	—	24322	24323	24324	24325	24326	24327	24328	24329
	POCKETS: 3 INNER: 0 OUTER: 3 REAR: 0	FEATURES	<ul style="list-style-type: none"> Weatherproof 300D oxford polyester shell Breathable PU coating, polyester mesh lining 				<ul style="list-style-type: none"> 3M™ Scotchlite™ Reflective Material Dual mic tabs 				
8366 ECONOMY RAIN		ORANGE	—	24362	24363	24364	24365	24366	24367	24368	24369
		LIME	—	24332	24333	24334	24335	24336	24337	24338	24339
	POCKETS: 3 INNER: 0 OUTER: 3 REAR: 0	FEATURES	<ul style="list-style-type: none"> 150D oxford polyester Waterproof PU coating 				<ul style="list-style-type: none"> Inset hood with drawstring STANDARD 100 by OEKO-TEX® certified 				
8918BK SUPPLEMENTAL CLASS E BLACK BOTTOM		ORANGE	—	—	—	—	—	—	—	—	
		LIME	—	25012	25013	25014	25015	25016	25017	25018	25019
	POCKETS: 1 INNER: 0 OUTER: 1 REAR: 0	FEATURES	<ul style="list-style-type: none"> Weatherproof 300D oxford polyester shell Breathable PU coating 				<ul style="list-style-type: none"> 3M™ Scotchlite™ Reflective Material Adjustable elastic suspenders, R cargo pocket 				
8915BK SUPPLEMENTAL CLASS E BLACK BOTTOM		ORANGE	—	—	—	—	—	—	—	—	
		LIME	—	25422	25423	25424	25425	25426	25427	25428	25429
	POCKETS: 1 INNER: 0 OUTER: 1 REAR: 0	FEATURES	<ul style="list-style-type: none"> Weatherproof 300D oxford polyester shell Breathable PU coating 				<ul style="list-style-type: none"> 3M™ Scotchlite™ Reflective Material Elastic waistband, R leg cargo pocket 				
8915 SUPPLEMENTAL CLASS E RAIN		ORANGE	—	24412	24413	24414	24415	24416	24417	24418	24419
		LIME	—	24422	24423	24424	24425	24426	24427	24428	24429
	POCKETS: 1 INNER: 0 OUTER: 1 REAR: 0	FEATURES	<ul style="list-style-type: none"> Weatherproof 300D oxford polyester shell Breathable PU coating 				<ul style="list-style-type: none"> 3M™ Scotchlite™ Reflective Material Elastic waistband, R leg cargo pocket 				
8916 ECONOMY RAIN		ORANGE	—	25442	25443	25444	25445	25446	25447	25448	25449
		LIME	—	25342	25343	25344	25345	25346	25347	25348	25349
	POCKETS: 0 INNER: 0 OUTER: 0 REAR: 0	FEATURES	<ul style="list-style-type: none"> Weatherproof 150D oxford polyester Waterproof PU coating 				<ul style="list-style-type: none"> Elastic waistband Boot snap adjustment 				
8376K ECONOMY LIGHTWEIGHT RAIN		ORANGE	—	—	25333	25334	25335	25336	—	—	—
		LIME	—	—	25433	25434	25435	25436	—	—	—
	POCKETS: 3 INNER: 0 OUTER: 3 REAR: 0	FEATURES	<ul style="list-style-type: none"> Weatherproof 150D oxford polyester Waterproof PU coating 				<ul style="list-style-type: none"> Elastic waistband & boot snap adjustment Inset hood with drawstring 				

HEADWEAR & ACCESSORY MODELS

MODEL		OS			MODEL		S/M	L/XL
8930 BASEBALL CAP 	ORANGE	23238			8931 REFLECTIVE STRETCH-FIT HAT 	LIME	23241	23243
	LIME	23239				LIME with logo	23240	23242
	FEATURES	<ul style="list-style-type: none"> • 150D oxford polyester • Mesh venting panels 				FEATURES	<ul style="list-style-type: none"> • Breathable mesh side • Gray visor interior 	
8005 MESH NECK SHADE 	ORANGE	29051			8933 REFLECTIVE SNAPBACK HAT 	LIME	23245	
	LIME	29053				LIME with logo	23244	
	FEATURES	<ul style="list-style-type: none"> • Polyester mesh • Reflective material stripe 				FEATURES	<ul style="list-style-type: none"> • Breathable mesh side • Gray visor interior 	
8006 NECK SHADE 	ORANGE	29061						
	LIME	29063						
	FEATURES	<ul style="list-style-type: none"> • Polyester solid fabric • Reflective binding 				<ul style="list-style-type: none"> • Hook & loop closures • Attaches to hard hat suspension headbands 		
8004 SEAT BELT COVER 	ORANGE	29041						
	LIME	29043						
	FEATURES	<ul style="list-style-type: none"> • Polyester solid fabric • Hook & loop closures 				<ul style="list-style-type: none"> • Fits standard width seat belt harness • 5½" open; 2" closed 		
MODEL		S/M	L/XL	2XL/3XL				
8935 RANGER HAT 	ORANGE	23257	23258	23259				
	LIME	23259	23260	23261				
	FEATURES	<ul style="list-style-type: none"> • 150D oxford polyester • Mesh venting panels 				<ul style="list-style-type: none"> • Three sizes: S/M 21-22.5", L/XL 22.5-24", 2XL/3XL 24-25.5" 		
8001 ARM/LEG BAND - SNAP CLOSURE 	ORANGE	29011	29012					
	LIME	29013	29014					
	FEATURES	<ul style="list-style-type: none"> • Knit elastic band • 3M™ Scotchlite™ Reflective Material 				<ul style="list-style-type: none"> • Two sizes: S/M 12", L/XL 15" • 2" wide 		

INDEX

HEADWEAR & ACCS. SERIES



THE FOUNDATION OF SAFETY

PROTECTION

PREVENTION

ELEMENTS

When it comes to laying the groundwork for safety, everything starts with PPE. What started with one product has evolved into three full-blown pillars upon which the entire line of Tenacious Work Gear® is built; all precision crafted to provide protection, promote prevention and manage the elements for workers on jobsites the world over.



| ERGODYNE TENACIOUS WORK GEAR |

| UTTERLY OBSESSED & INTENSELY COMMITTED TO WORKER SAFETY SINCE 1983 |

TENACIOUS WORK GEAR // BUT WAIT! THERE'S MORE!

PROTECTION

PREVENTION

ELEMENTS



OUR SOLUTIONS:

PROFLEX® GLOVES
PROFLEX® KNEE PADS
PROFLEX® SUPPORTS

GLOWEAR® HI-VIS APPAREL

SKULLERZ® EYE PROTECTION
SKULLERZ® HEAD PROTECTION
SKULLERZ® FACE MASKS + COVERINGS

Hard hats, hi-vis, safety glasses... these are your OGs of PPE. If it shields workers from the everyday perils of the work day, you'll find it in Skullerz®, ProFlex® or GloWear®. Multigrade dome defense and specs workers actually want to wear. Bare-knuckle banishing gloves, surgery-saving knee pads and more hi-vis than you can shake a flashlight at. Roll it all up and you've got head-to-toe coverage for every comrade in the crew.



OUR SOLUTIONS:

SQUIDS® TOOL TETHERING SYSTEMS
SQUIDS® DEVICE MANAGEMENT

ARSENAL® GEAR + TOOL STORAGE

An apple dropping off a tree during a mathematician's idyll in the English countryside is one thing. Sledgehammers plummeting forty stories onto a busy worksite is another. Those grinding it out daily on the highest and harshest know that hope and pray isn't a policy, which is why Squids® Tool Tethering Solutions and Arsenal® Gear Bags are dutifully designed for the safety of workers and equipment, the productivity of the jobsite and the banishment of accidents waiting to happen.



OUR SOLUTIONS:

CHILL-ITS® COOLING PRODUCTS

KREW'D® SKIN PROTECTION

SHAX® PORTABLE WORK SHELTERS

N-FERNO® WARMING PRODUCTS

TREX® TRACTION ACCESSORIES

You can't control the weather, but you can make sure it doesn't control crews. Batten down the hatches for earth, wind and fire with advanced Chill-Its® cooling tech, heat-trapping N-Ferno® gear, weather-withstanding SHAX® Tents and KREW'D®'s no BS SPF, all specifically engineered so that workers can go toe to toe with Mother Nature—and win.



A KLEIN TOOLS COMPANY

INTERGALACTIC HEADQUARTERS:

44° 58' 18.31" N 93° 09' 12.88" W ALT. 934 FT.
1021 BANDANA BOULEVARD EAST
SUITE 220 SAINT PAUL, MN, USA 55108

PHONE 651 642 9889 // 800 225 8238

ERGODYNE.COM

©2022 Tenacious Holdings Inc. All Rights Reserved. All Wrongs Reversed. Ergodyne, Ergoman and design, Ergodyne badge logo, E logo, Tenacious Work Gear, Be Tenacious, Arsenal, Chill-lts, DROP COPS, KREW'D, GloWear, N-Ferno, ProFlex, SHAX, Skullerz, Slips, Squids, Sticky Fingers and TREX are registered trademarks of Tenacious Holdings Incorporated and protected in the U.S. and abroad. AVC, Beverage Extrication Tool, Buddy System, CHILLX, Comfort Hinge, Drops Free Zone, DSX, Fog-Off, Hot Rox, Instrumentation Traps, Make the Workplace a Betterplace, Open-Center Stay, Orange Squad, Power Panel Positioner, Products for Occupational Athletes, QuickCuff, SOLARX, Squad Box, Storm Drains, Team Extreme, Team Tenacious, Tenacious Assault Vehicle, Tenacious Nation, Tenacious Talks, Tenacious Testers, Tenacious Toilet, Tenacious-U, Tena-Grip, Tena-Coat, Tenalux, THE NO BS SPF, Tool Tails, Tool Trap, Workday2Weekend and WSX are trademarks of Tenacious Holdings Incorporated. Trademarks of companies mentioned herein appear for identification purposes only and are the property of their respective companies. All other product names mentioned herein may be trademarks and/or registered trademarks of their respective owners. Ergodyne is a registered trademark of Tenacious Holdings Inc. (dba Ergodyne) is a Klein Tools Company.

ergodyne®

GLOWEAR® HI-VIS:
BE SEEN. FEEL HEARD.