

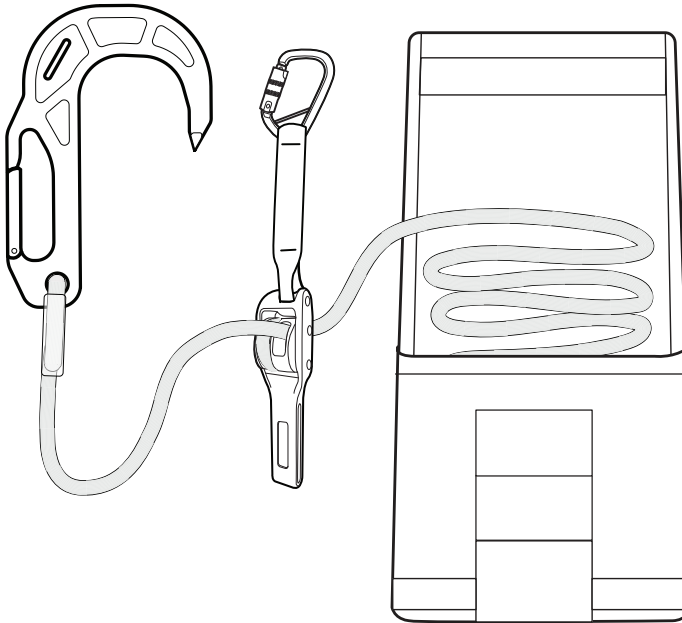

LEVR™ ESCAPE SYSTEM



⚠ WARNINGS

Activities involving the use of this equipment are potentially dangerous. Special knowledge and training are required to use this product. You are responsible for your own actions and decisions. Before using this device, you must:

- Read and understand these user instructions and warnings.
- Familiarize yourself with its capabilities and limitations.
- Get specific training in its proper use.
- Understand and accept the risks involved.

FAILURE TO HEED ANY OF THESE WARNINGS MAY RESULT IN SEVERE INJURY OR DEATH.



Imminent risk of serious injury or death.



Imminent risk of accident or injury.



Appropriate function or use.



Equipment incompatibility.

Manual refers to multiple product configurations.



Find the latest version and translations of this manual at cmcpro.com

LEVR™ ESCAPE SYSTEM



MEETS THE FIRE ESCAPE SYSTEM REQUIREMENTS OF NFPA 1983, INCORPORATED IN THE 2022 EDITION OF NFPA 2500. DO NOT DISASSEMBLE.

- 50036X CMC LEVR™ ESCAPE SYSTEM, RATED FOR ESCAPE USE (E)

FIRE ESCAPE WEB



MEETS THE FIRE ESCAPE WEBBING REQUIREMENTS OF NFPA 1983, INCORPORATED IN THE 2022 EDITION OF NFPA 2500.

- 200517-01, CMC FR WEBBING
 - MINIMUM BREAKING STRENGTH: 26 KN
 - PERIMETER: 30 MM
 - TYPE OF FIBER(S): 99% TECHNORA® / 1% KEVLAR®
 - ELONGATION @ 1.35 KN (300 LBF): 0.6%
 - ELONGATION @ 2.7 KN (600 LBF): 1.2%
 - ELONGATION @ 4.4 KN (1,000 LBF): 1.6%

LEVR™ DESCENDER



MEETS THE DESCENT CONTROL DEVICE REQUIREMENTS OF NFPA 1983, INCORPORATED IN THE 2022 EDITION OF NFPA 2500.

- 30095X LEVR™ DESCENDER, RATED FOR ESCAPE USE (E)

THIS DESCENT CONTROL DEVICE HAS PASSED THE MANNER OF FUNCTION AND HOLDING LOAD TESTS USING THE FOLLOWING ESCAPE WEBBING: CMC FIRE ESCAPE WEB P/N 200517-01, PERIMETER 30.0 MM.

FLASH.2™ AND FLASH.G™ ESCAPE ANCHOR



MEETS THE ESCAPE ANCHOR AND DESCENT CONTROL DEVICE REQUIREMENTS OF NFPA 1983, INCORPORATED IN THE 2022 EDITION OF NFPA 2500.

- 300983-02 FLASH.2™ AND 300973-01 FLASH.G™, ESCAPE ANCHOR MBS 13.5 KN (3,034 LBF)
- 300983-02 FLASH.2™ AND 300973-01 FLASH.G™, EMERGENCY DESCENT CONTROL RATED FOR ESCAPE USE (E)

THE DESCENT CONTROL DEVICE HAS PASSED THE MANNER OF FUNCTION AND HOLDING LOAD TESTS USING THE FOLLOWING ESCAPE WEBBING: CMC FIRE ESCAPE WEB P/N 200517-01, PERIMETER 30.0 MM.

CONTENTS	Page No.
1 LEVR ESCAPE SYSTEM COMPONENTS	4
2 TRACEABILITY & MARKINGS	6
3 NOMENCLATURE	8
4 FIELD OF APPLICATION	9
5 INSPECTION POINTS TO VERIFY	9
6 MAINTENANCE & CARE	9
7 USING THE LEVR DESCENDER	9
DESCENDING	9
8 FLASH ESCAPE ANCHOR USE	10
DIRECT CONNECTION	10
REMOTE ANCHOR WITH FLASH.G	10
REMOTE ANCHOR WITH FLASH.2	11
9 FLASH ESCAPE DESCENDER USE	12
FLASH.G DESCENDER USE	12
FLASH.2 DESCENDER USE	12
10 EQUIPMENT RECORDS	13
DESCENDER USE TIE-OFF	13
11 MANUAL TEXT	14

1

LEVR ESCAPE SYSTEM COMPONENTS

LEVR BT Escape System

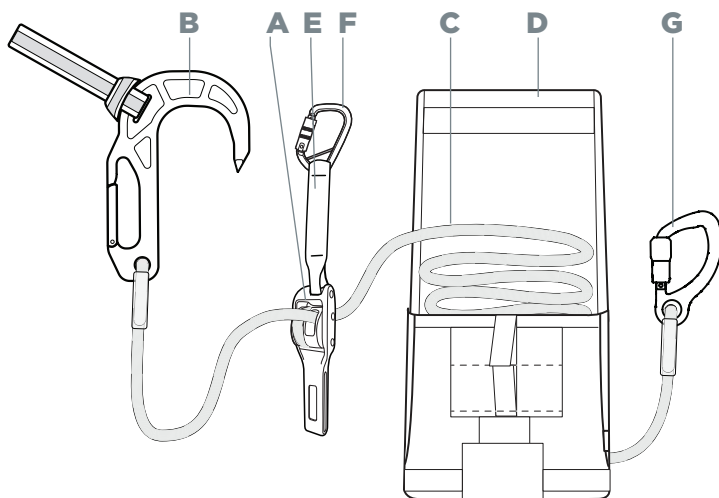

- A** LEVR Descender
- B** Flash.G Escape Anchor with Deployment Tether
- C** Fire Escape Web - 50 ft (15 m)
- D** BT Fire Escape Bag
- E** Sewn Personal Tether
- F** ProTech Auto-Lock Carabiner with Keeper
- G** Captive Eye Carabiner

LEVR Escape System

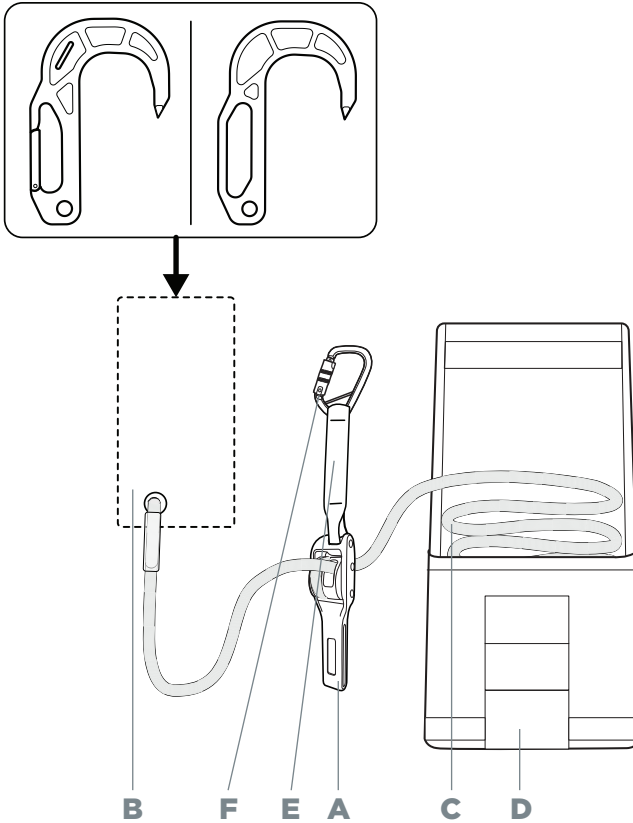

- A** LEVR Descender
- B** Flash.G or Flash.2 Escape Anchor
- C** Fire Escape Web - 50 ft (15 m)
- D** Standard Fire Escape Bag
- E** Sewn Personal Tether
- F** ProTech Auto-Lock Carabiner with Keeper

2

TRACEABILITY & MARKINGS

LEVR Descender

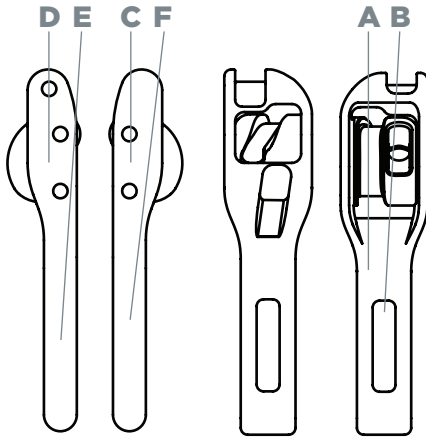

- A** Manufacturer Identification
- B** Product Name
- C** Country of Manufacture
- D** Seal of Certifying Agency
- E** NFPA Classification
- F** Part Number and Lot Number

FLASH.G and FLASH.2 Escape Anchor

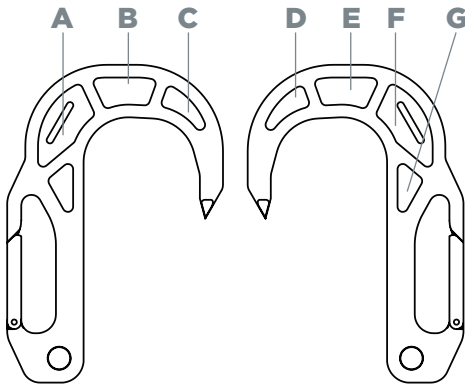

FLASH.G

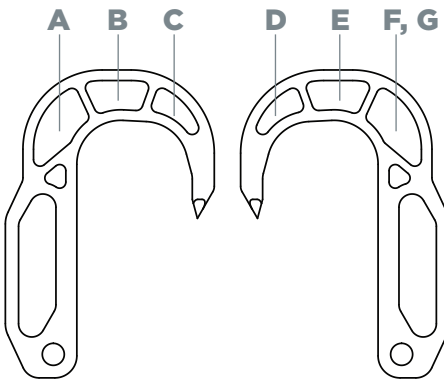

FLASH.2

- A** Manufacturer Identification
- B** Product Name
- C** Country of Manufacture
- D** Carefully Read the Instructions before Use 
- E** Seal of Certifying Agency
- F** NFPA Classification
- G** Part Number and Lot Number

3

NOMENCLATURE

LEVR Descender

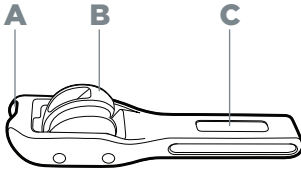

- A** Personal Tether Attachment
- B** Pivoting Bollard
- C** Control Handle

FLASH.G and FLASH.2 Escape Anchor

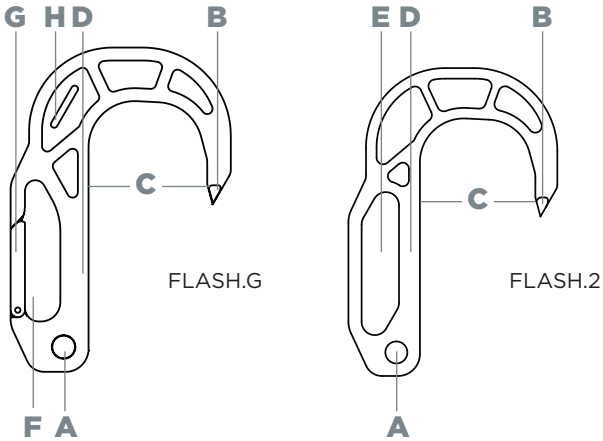

- A** Escape Line Attachment Eye
- B** Tip
- C** Throat
- D** Shank
- E** Hitching Slot
- F** Gated Slot
- G** Gate
- H** Deployment Tether Slot

4

FIELD OF APPLICATION

SEE TEXT FOR MORE

5

INSPECTION POINTS TO VERIFY

SEE TEXT FOR MORE

6

MAINTENANCE & CARE

SEE TEXT FOR MORE

7

USING THE LEVR DESCENDER

SEE TEXT FOR MORE

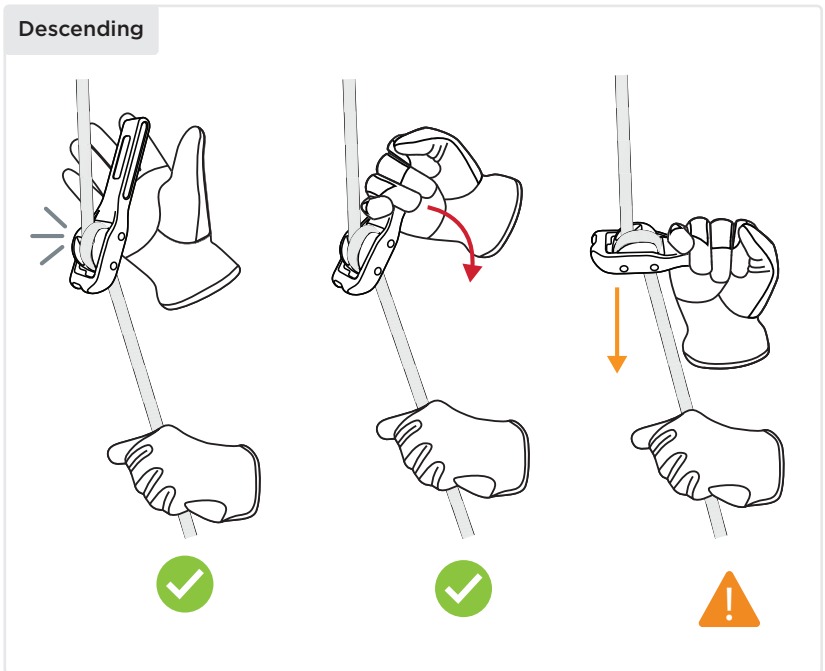

8

FLASH ESCAPE ANCHOR USE SEE TEXT FOR MORE

Direct Connection

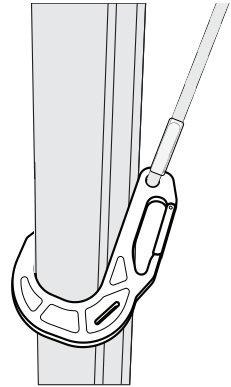
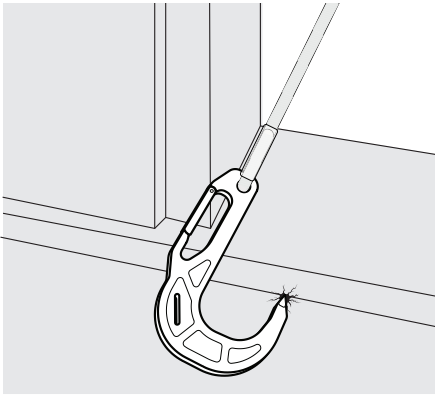

Remote Anchor with Flash.G

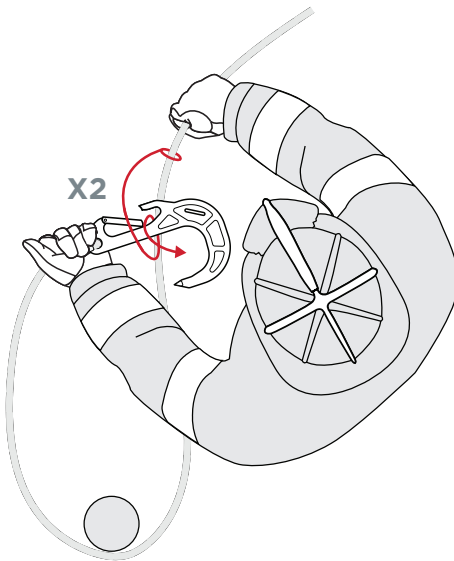

Remote Anchor with Flash.2

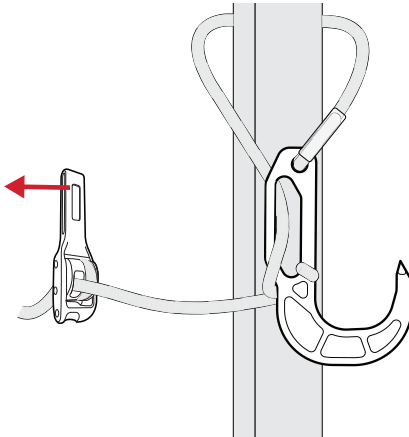
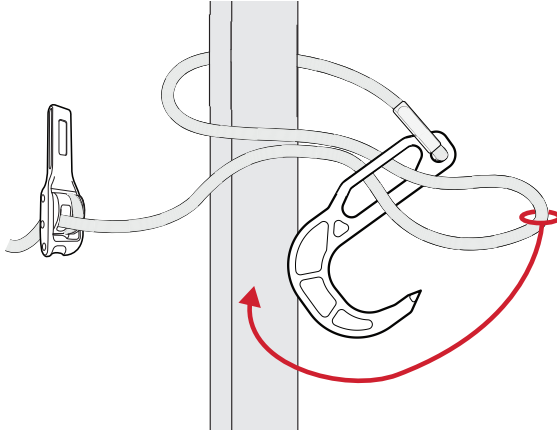
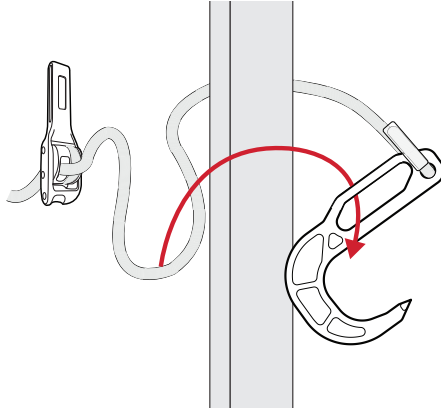

9

FLASH ESCAPE DESCENDER USE SEE TEXT FOR MORE

Flash.G Descender Use

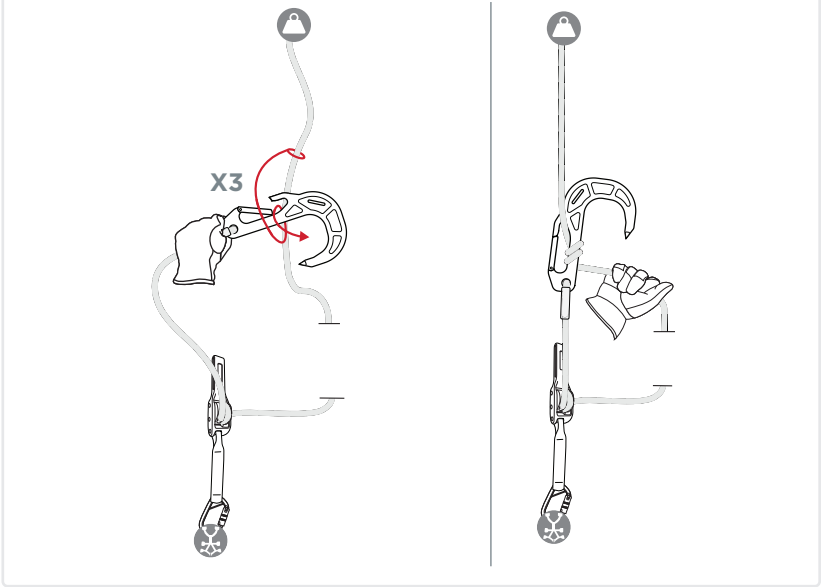

Flash.2 Descender Use

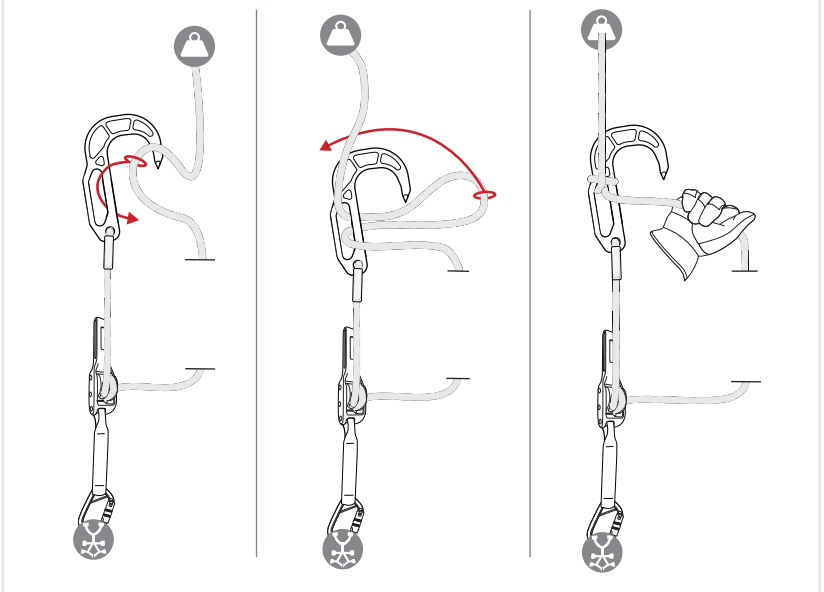

Descender Use Tie-Off

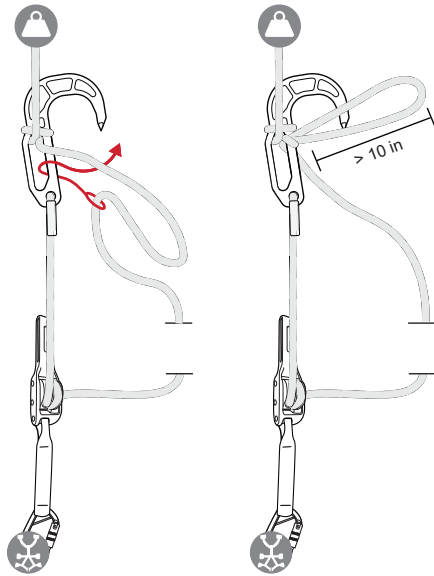

10

EQUIPMENT RECORDS

SEE TEXT FOR MORE

Equipment Record Table

Product Name		Product Type	
Manufacturer Name & Address	CMC Rescue, Inc. 6740 Cortona Drive Goleta, CA 93117, US	Manufacturer Contact Information	Tel: 805-562-9120 Tel: 800-235-5741 info@cmcpro.com
User Name & Address		Product Serial #	
Year of Manufacture		Purchase Date	
First Use Date		Expiration Date	

Periodic Inspection Sheet

Check Date	Notes/Results	Inspector Name & Signature	Date of Next Check

1. SYSTEM CONFIGURATIONS

See section for details.

2. TRACEABILITY & MARKINGS

See section for details.

3. NOMENCLATURE

See section for details.

4. FIELD OF APPLICATION

This product is manufactured for emergency escape. It shall not be used outside of its limitations, or for any purpose other than that for which it is intended. The LEVR Escape System is available in multiple configurations. Various components are also sold separately including the Flash.G, Flash.2, and ProTech™ Auto-Lock Carabiner.

STANDARDS & APPLICATIONS

This product and its components are classified to NFPA 1983, incorporated in the 2022 Edition of NFPA 2500 for the following applications:

LEVR Escape System
• Fire Escape System

LEVR Descender
• Escape Descent Control Device

Flash.G Escape Anchor
• Escape Anchor Device
• Escape Descent Control Device

Flash.2 Escape Anchor
• Escape Anchor Device
• Escape Descent Control Device

Fire Escape Web
• Fire Escape Webbing

ProTech Auto-Lock Carabiner with Keeper
• Emergency Services Carabiner, Technical Use

Captive Eye Carabiner (BT System Only)
• Emergency Services Carabiner, Technical Use

USER INFORMATION

User Information shall be provided to the user of the product. NFPA Standard 1983, incorporated into the 2022 edition of NFPA 2500 recommends separating the User Information from the equipment and retaining the information in a permanent record. The standard also recommends making a copy of the User Information to keep with the equipment and that the information should be referred to before and after each use. Additional information regarding life safety equipment can be found in NFPA 1500 and NFPA 1553 and NFPA 1983, incorporated in the 2022 edition of NFPA 2500.

RESPONSIBILITY

Activities involving the use of this device are inherently dangerous. The user shall assume all risks and responsibilities for any damage, injury or death, which may occur during or following the incorrect use of this equipment. Observe relevant national regulations.

These instructions explain the correct use of your equipment. The warning symbols inform you of some potential dangers related to the use of your equipment, but it is impossible to describe them all. You are responsible for heeding each warning and using your equipment correctly. Any misuse of this equipment will create additional dangers. Contact CMC if you have any questions or difficulty understanding these instructions. Check cmpro.com for updates and additional information.

Before using this equipment, you must:

- Read and understand these instructions and warnings.
- Obtain specific training and competency in its proper use.
- Familiarize yourself with its capabilities and limitations.
- Understand and accept the risks involved.
- Have a rescue plan in place to deal with any emergencies that could arise during use of the device.
- Be medically fit for activities at height and capable of controlling your own security and emergency situations.
- Check equipment before and after use.

5. INSPECTION POINTS TO VERIFY

INSPECTION

User safety depends on equipment integrity. Equipment should be thoroughly inspected prior to being placed into service and before and after each use. In addition, CMC recommends performing a detailed periodic inspection, by a competent person that meets your department's training standards, at least every 12 months depending on current local regulations and conditions of use.

Keep a record of the date, person performing the inspection and results, as well as the date of first use, name of users and any other pertinent information necessary to keep accurate track of the equipment's usage history in the equipment log or on a tag that attaches to the equipment. Each user should be trained in equipment inspection and should inspect the equipment before each use. When inspecting the system, follow the manufacturer's recommendations provided in this manual and any documentation provided with the LEVR Escape System components.

Verify that this product is compatible with the other equipment in the system and that its intended applications meet current standards. Equipment used with this product must meet regulatory requirements in your jurisdiction and/or country, and provide safe, functional interaction.

WARNING: Danger may arise and functionality may be compromised by combining other equipment with this product. User assumes all responsibility for non-standard use of this product or added components.

BEFORE EACH USE

- Visually check the parts for any signs of damage such as cracks, wear, corrosion, deformation or discoloration from heat. Minor nicks or sharp spots may be smoothed with emery cloth.
- Ensure that the markings are legible and that the materials do not show signs of wear preventing it from normal function. Confirm the tip of the hook does not show signs of wear preventing it from engaging a structure.
- Ensure smooth and full range of movement of the cam and control handle. If the LEVR does not pass inspection or if there is any doubt as to the safety or serviceability of the device, remove it from service and destroy it.
- Inspect the connection of the escape line to the hook, make sure the escape line is not damaged and that the sewn end (if used) is fully covered by the protective tube and that there are no broken or missing stitches.
- Fire Escape Web should be inspected periodically to verify that the web is in serviceable condition. Look for cuts, abrasions, or fuzzy areas that would indicate the web has been used or exposed to abrasion or sharp edges. If the web does not pass inspection or if there is any doubt about the safety or serviceability of the web, remove the web from service and destroy it.
- The LEVR is pre-rigged with approved FR Escape Web prior to shipping from CMC. If web replacement is necessary, contact CMC Customer Support.

DURING USE

- Follow training procedures and departmental guidance on how to properly evaluate emergency escape equipment during use.
- Selection of suitable anchor points or structures is highly dependent on each bailout situation and is too complex to be comprehensively covered in this manual.

WARNING: The selection of an anchor point of adequate strength and the use of proper anchoring technique is essential for the safe use of the escape anchor.

6. MAINTENANCE & CARE

CARRYING, STORAGE, AND TRANSPORT

LEVR ESCAPE SYSTEM

- Clean and dry this equipment after each use to remove any dust, debris and moisture. Use clean water to wash off any dirt or debris. Do not use a pressure washer to clean the device.
- If device gets wet, allow the device to air dry at temperatures between 10° C (50° F) and 30° C (86° F), keep away from direct heat.
- During use, carrying, storage, and transport, keep the equipment away from acids, alkalis, rust and strong chemicals.
- Do not expose the equipment to flame or high temperatures. Store in a cool, dry location.
- Do not store where the equipment may be exposed to moist air, particularly where dissimilar metals are stored together.
- Ensure that the equipment is protected from external impact and keep out of direct sunlight.

LEVR DESCENDER

- If the device gets dirty, clean it with a mixture of warm water and mild detergent.
 - Do not use corrosive substances or petroleum-based solvents.
 - Rinse in clean warm water, shake off excess water and dry at room temperature.
 - Repeat as necessary.
- WARNING:** Failure to follow these instructions may endanger life.

FIRE ESCAPE WEB

Fire Escape Web should only be used with a life safety harness or escape belt. Protect the web from abrasion during storage and while carrying. During use, protect the web from any sharp or abrasive edges by padding the edges or rigging the web to avoid the edges. Carry the web where it will be protected from exposure to high heat or direct flame.

LIFESPAN / RETIREMENT

The service life of equipment depends greatly on the type of use and the environment of use. CMC does not specify an expiration date for hardware because the service life depends greatly on how and where it is used. For softgoods including Fire Escape Web, CMC has set a lifespan of 10 years from the date of manufacture shown on the product label.

Retire the system if it is used in actual fire ground emergency escape, or if there is any doubt about its serviceability. Retirement is also a function of the operating conditions, level of use, and environmental conditions. Protect from sharp edges, open flame, extreme temperatures, chemicals, oils, moisture, and mechanical stress. A fall load or other exceptional event can lead to retirement after a single use. Any concerns about its safe use is cause for retirement. If the system or components are retired, it should be taken out of service and marked accordingly or destroyed to prevent further use.

- A product must be retired when:
 - It has reached the end of its established lifespan.
 - It has been subjected to a major event (fall, shockload etc.).
 - It has been exposed to extreme environments (sharp edges, extreme temperatures, corrosive environment etc.) or becomes contaminated (chemicals etc.).
 - It fails to pass inspection or there are any doubts about its reliability.
 - It has an uncertain usage history.
 - When it becomes obsolete due to changes in legislation, standards, technique or compatibility.
 - In general if there is any doubt about its condition of safe use.

WARRANTY & REPAIRS

If your CMC product has a defect due to workmanship or materials, please contact CMC Customer Support at info@cmcpro.com for warranty information and service. CMC's warranty does not cover damages caused by improper care, improper use, alterations and modifications, accidental damage or the natural breakdown of material over extended use and time. All repair work shall be performed by the manufacturer. All other work or modifications void the warranty and releases CMC from all liability and responsibility as the manufacturer.

MANUFACTURER INFORMATION

CMC Rescue, Inc.
6740 Cortona Drive
Goleta, CA 93117, USA
805-562-9120 / 800-235-5741
cmcpro.com | info@cmcpro.com
ISO 9001 Certified
©2021 CMC Rescue, Inc.

All rights reserved CMC and  are registered marks of CMC Rescue Inc.

7. USING THE LEVR DESCENDER

PRACTICE & TRAINING

Safe use of the LEVR requires familiarity with its operation and basic rappel skills. CMC strongly recommends training from a competent instructor and practice in both descending with the LEVR and in exiting windows. A safety belay should always be used when practicing, training, and learning to use the LEVR. Practice is essential. Additional items to remember:

- Use only certified CMC Fire Escape Web
- To prevent roll out when using carabiners, use only locking models. Verify that manual locking carabiners are locked. Verify on auto locking carabiners that the gate has closed completely.
- All users should acquire training from a competent instructor before use.
- Use an independent belay during all training exercises.

As with any life safety product, it is the responsibility of the user to inspect and verify correct function of the LEVR and all related components before and after each use to insure it performs as expected and is ready for emergency use.

EXITING THE STRUCTURE

The LEVR is designed to allow both hands to be used to exit a window or other opening in the structure. A safe descent requires a moderate amount of preplanning with time to set a secure anchor, remove any edge material that may damage the escape web, and to make sure the connector, LEVR and any other equipment clears the edge without damage or hanging up. When setting a remote anchor and moving to the point of egress, point the control handle towards the direction of travel to ensure smooth payout.

DESCENDING

- Start by loading the system with your body weight.
- When descending with the LEVR, always maintain control of the web tail.
- The LEVR can be operated with one hand on the control handle and one hand on the web tail, or the web tail can be routed through the same hand that is operating the control handle by passing the tail in-between the thumb and pointer finger of the hand grabbing the control handle and creating friction on the tail by squeezing the tail against the control handle. Training is essential for the safe operation of the LEVR in either the double or single hand method.
- Slowly pull the control lever towards your body to initiate your descent.
- Control the rate of descent by varying the degree of pull on the handle and the amount of friction on the web tail.
- To stop descending, release the handle and tighten

- the grasp on the web tail. The control handle must be released to stop the descent.
- Fully engage the control handle will cause a rapid descent. Always use a backup when training.

REPACKING THE SYSTEM

When repacking the system into the supplied CMC carry bag, flake the web into the main pouch to minimize twisting during deployment. Also make sure that the Flash Escape Anchor and the LEVR are properly stored in their respective holders and will deploy freely. If storing the LEVR Escape System directly in the bunker pants pocket or using a different external bag than the supplied CMC carry bag ensure that the web is properly flaked and the hardware is packed such that it will deploy freely. To view a video with more information and detailed instructions on properly packing the LEVR Escape System, please visit cmcpro.com

8. FLASH ESCAPE ANCHOR USE

The Flash.G Escape Anchor and Flash.2 Escape Anchor are designed to attach escape line to a secure anchor point for emergency egress. The selection of an anchor point of adequate strength is essential for the safe use of the escape anchor. The Flash Escape Anchors are attached in two general ways: Direct Connection and Remote Anchor.

DIRECT CONNECTION

In this method, the escape anchor is directly connected to a suitable structure. The anchor either hooks around an object such as a pipe or railing, or the tip of the hook is used to engage an object such as a window sill where the tip engages and holds the anchor in place.

Whenever the tip of the anchor is used, embed it as deeply as possible into the structure before loading. Care should be given to load the anchor in line with the hook, and the anchor placement must avoid cantilevering the hook as this may cause the tip to disengage from the structure, or overload the hook. Tension must be maintained on the anchor and escape line continuously until the egress is complete. Failure to do so may allow the anchor to release from the structure.

REMOTE ANCHOR

In this method, the escape line is wrapped around an object or structure and the escape anchor is used to connect back to the escape line, forming a loop.

FLASH.G REMOTE ANCHOR

Hold the escape anchor in one hand by grabbing it near the Escape Line Attachment Eye. Pass it around the object or structure and use the other hand to wrap the escape line two times around the entire escape anchor such that the escape line passes through the gate and enters the gated slot two times. This will create two wraps of escape line around the shank of the hook, securing the loop. Make sure that both wraps of line are fully inside of the gated slot, and that the gate has closed completely before loading the anchor.

FLASH.2 REMOTE ANCHOR

Pass the anchor around the structure or object. Secure the loop by passing a bight of escape line through the hitching slot and wrapping it around the hook as shown.

9. FLASH ESCAPE DESCENDER USE

The Flash escape anchor can be used as an for lowering a victim using the tail end of the escape system. In this method, the device does not function as an escape anchor, but rather as the friction inducing descent device.

WARNING:

- For advanced users with proper training only!
- The rescuer must create an alternative anchorage point from which to perform this action.
- The victim must be securely connected to the escape line.
- The device is not auto-locking. The rescuer must maintain control of the tail at all times or tie off the system.
- If the rescuer intends to bail out immediately after lowering a victim, care must be taken that the escape line is sufficiently long to reach the ground, and that the victim can be quickly disconnected upon reaching the ground.

FLASH.G DESCENDER USE

- Locate the connector at the end of the escape line.
- Deploy the Flash.G anchor/descender from its stowage and hold the unit by the shank in one hand with the attachment-eye end of the hook oriented towards the body.
- Pass the escape line into the same hand holding the escape anchor.
- Pass the end of the escape line around the shank of the hook and through the gate three times.
- Suitably anchor the system. It is absolutely critical to ensure that the system is anchored before load is applied. Anchoring must consider circumstances and departmental policies.
- Attach the end of the escape line to the person being lowered, using a connector if available.
- Firmly grab the tail of the escape line before loading the system.
- Slowly reduce the tension on the tail to initiate descent.

FLASH.2 DESCENDER USE

- Locate the tail end of the escape line. On the LEVR.20 Escape System, the captive eye carabiner is sewn onto the line for easy attachment to the victim. In systems without this connector, a connector can be added or a deployment approved knot can be used for securing the victim.
- Deploy the Flash.2 anchor/descender from its stowage and hold the unit by the shank in one hand with the attachment-eye end of the hook oriented towards the body.
- Create a munter hitch by passing a bight of escape line through the hitching slot and around the tip of the anchor.
- Suitably anchor the system. It is absolutely critical to ensure that the system is anchored before load is applied. Anchoring must consider circumstances and departmental policies.
- Attach the end of the escape line to the person being lowered, using a connector if available.
- Firmly grab the tail of the escape line before loading the system.
- Slowly reduce the tension on the tail to initiate descent.

TIE-OFF METHOD

Both the Flash.G and Flash.2 can be tied off using the method shown. Make sure the bight of rope extending from the half-hitch around the shank is at least 10' long.

Tie-off methods are a certification requirement for escape descent control devices. The time-critical nature of emergency bailout conditions may preclude tie-off of the system. Refer to departmental training and guidance for determining when tie-offs may be appropriate.

10. EQUIPMENT RECORDS

Equipment should be thoroughly inspected prior to being placed into service and before and after each use. In addition, CMC recommends performing a detailed periodic inspection, by a competent person, at least every 12 months depending on current local regulations and conditions of use. A sample equipment table is provided to assist with recording the results of periodic inspections. Users should maintain records for each component of the LEVR Escape System.



CMC Rescue, Inc.
6740 Cortona Drive
Goleta, CA 93117, USA
805-562-9120 / 800-235-5741
cmcpro.com

ISO 9001 Certified
CMC Rescue, Inc. All rights reserved
CMC and **X** are registered marks of CMC Rescue Inc.
Control No.: 910016_Rev00