

COMMAND LIGHT

ELEVATE YOUR SCENE LIGHTING

SEE THE DIFFERENCE

PERIMETER LIGHTING

VS

COMMAND LIGHT TOWERS

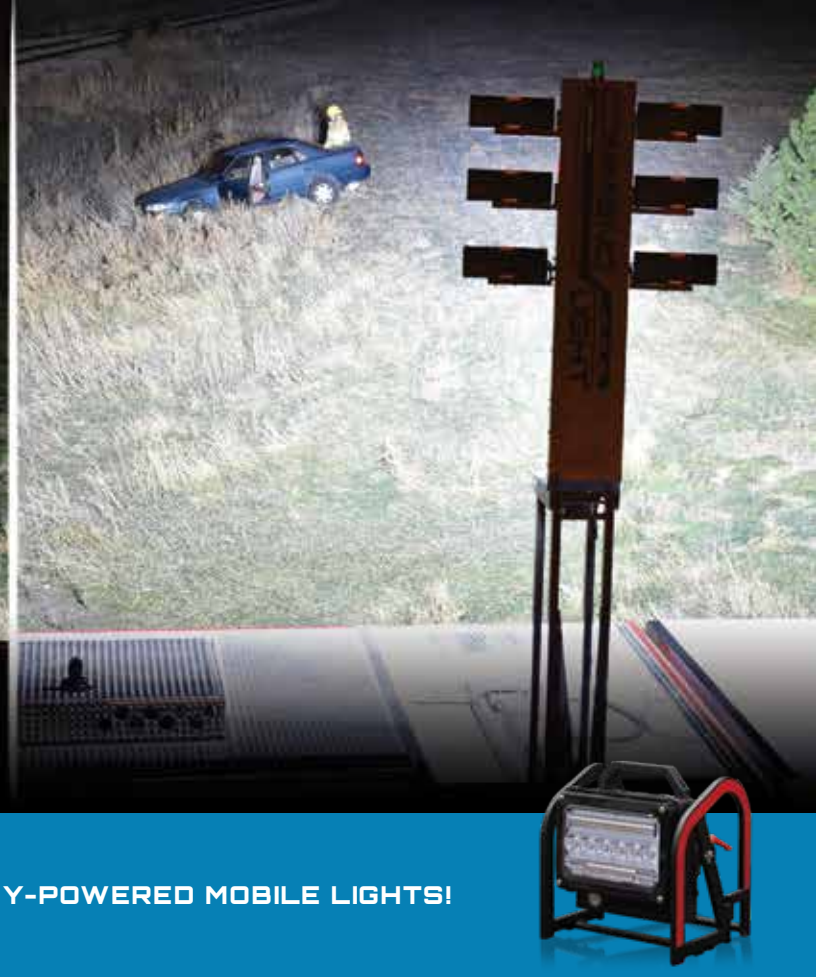

PLUS, BATTERY-POWERED MOBILE LIGHTS!



OUR DIFFERENCE.

TOWER DEPLOYMENT

- ✓ Feature a patented (US Patent #5303621) movement, allowing endless positions
- ✓ Can overhang the side of a vehicle in Command Light's exclusive streetlight position
- ✓ Deploys fully in less than 15 seconds with the press of a button
- ✓ Stows quickly with a one-touch auto-park feature

TOWER DURABILITY

- ✓ 100% electric, meaning no air or hydraulics
- ✓ Virtually maintenance free and operable in ALL weather conditions
- ✓ NFPA 1901 compliant and tested to winds up to 90 mph
- ✓ Built with aircraft-grade aluminum alloy to add strength while reducing weight

INDUSTRY-LEADING 5-YEAR WARRANTY

Command Light products come with an industry-leading, five-year warranty against any defects in materials and workmanship when used and operated for a period of five years. Excludes malfunctions related to misuse, accident, neglect or normal wear-and-tear, as well as batteries and light-producing components (bulbs, lasers, LEDs), which come with their own manufacturer's warranty.



BUILD, SPEC AND PRICE YOUR LIGHT TOWER
[COMMANDLIGHT.COM/BUILD](https://www.commandlight.com/build)



FOUR WAYS CREWS CAN
DIRECT LIGHT
WITH COMMAND LIGHT



C-SIDE ILLUMINATION



OPTIONAL BACKLIGHT



STREETLAMP POSITION



360° ROTATION

DIRECTIONAL LIGHTING VS TRUCK-MOUNTED PERIMETER LIGHTS

With new LEDs on the market, it's tempting to equip trucks with only corner light fixtures, but don't be fooled. With truck-mounted perimeter LEDs, only HALF of the light is directed at the scene, and this eye-level light creates glare for crews. Meanwhile, Command Light's patented light tower movement clusters ALL of your fixtures, allowing light to gather and be directed for maximum output, much like sport stadium lights,. Plus, Command Light's all-new Trident Tripod and EOS-RDL (Rapid Deploy Light) let you position light where no truck can.

COMMAND LIGHT TRIPOD
ALL-NEW TRIDENT TRIPOD



PERIMETER LIGHTS
UNABLE TO BE DIRECTED AT THE C-SIDE OF A STRUCTURE



COMMAND LIGHT'S BATTERY TRIPOD CAN MOUNT TO YOUR TRUCK FOR VEHICLE LIGHTING AND DETACH FOR C-SIDE STRUCTURAL LIGHTING



COMMAND LIGHT TOWER
CL602A-W2 WITH BACKLIGHT



PERIMETER LIGHTS
1 WHELEN 900 SERIES AND 2 WHELEN M9S ON EACH SIDE OF THE TRUCK



PERIMETER LIGHTS
1 WHELEN M9 AND 2 FIRETECH FT-B-45 (46" LED STICKS) ON EACH SIDE OF THE TRUCK



SCENE LIGHT

WHICH LIGHTING IS RIGHT FOR YOU?

Command Light specializes in emergency scene lighting, offering a patented light tower design that has been trusted for decades, and now, it has added AC- and DC-powered tripods for mobile illumination. To help you navigate Command Light's broad lineup, this catalog is organized by tower/tripod height (ie. Series), number of heads, power requirements and optional features.

1 SELECT THE IDEAL HEIGHT

 <p>MOBILE LIGHTS CHOOSE POWER + LEDS Pages 8-11</p>	 <p>CL SERIES MOST POWERFUL Pages 12-15</p>	 <p>KNIGHT SERIES MID-SIZE HEIGHT Pages 16-19</p>	 <p>SHADOW SERIES SHORTEST TOWER Pages 20-24</p>	 <p>C-LITE COMPACT LIGHTING Page 25</p>
---	---	---	---	---

CHOOSE YOUR FIXTURE/POWER CONFIGURATION



2 # OF HEADS CHOOSE FROM 1, 2, 3, 4, 6 OR 8

The number of heads will determine how much light you can gather and direct using rotation, angling and optional tower backlight.

8 HEAD	Page 13
6 HEAD	Pages 14, 17
4 HEAD	Pages 15, 18, 21, 23
3 HEAD	Page 23
2 HEAD	Pages 9, 10, 22, 23, 25
1 HEAD	Pages 9, 10, 25
SLIM	Pages 19, 24

3 POWER AC, DC, AC/DC OR BATTERY

Do you need an AC (115/230V) powered unit or DC (12V or 24V) power? Look for the **AC** and **DC** chart labels to help you pinpoint the right towers. Meanwhile, our tripods are available in AC, DC Battery or Truck 12V DC power options.

4 LIGHT FIXTURES LED OR QUARTZ HALOGEN

Looking for LEDs (long-lasting lamps at a lower power draw), or quartz halogen (bright fixtures for less cost)? Refer to the **LEDS** and **QUARTZ HALOGEN** labels.

MORE INFO Pages 6-7

For Traffic Flow Boards, please see Pages 26-27

ADD OPTIONAL TOWER FEATURES

5 UPGRADES



BACKLIGHT

Command Light's backlight option enables the bottom row of lamp heads to rotate 180°, making it possible to light both sides of the scene.



TOP-MOUNTED STROBE

Alert oncoming traffic earlier with a strobe mounted on top of the light tower. Available in green, red, amber, blue or clear.



LONG ARM

Increase the Shadow Series' reach, up to 6.5' with this optional arm.



CUSTOM COLORS

Optional colors include powder-coated white, red and black. Towers can be wet painted to any color. (Standard: Powder-coated gray.)



STANDARD



POWDER-COATED OPTIONS



WET PAINT
(COLOR MATCH
TO TRUCK)



TOP-MOUNTED CAMERA

A top-mounted camera provides additional 360° views for apparatus operators, helping keep personnel safe on the fire ground. Choose from the INTEC, Safety Vision or Zone Defense video systems. Learn more about these cameras at commandlight.com/360-vehicle-cameras.



CONTROL OPTIONS



STANDARD

The Standard Controller comes with a 15 ft (4.5 m) umbilical cord and intuitive buttons, giving crews the ability to control every aspect of the tower and lights.



WIRELESS

Available on any Command Light tower, this optional Wireless Controller has a range of up to 150 ft (45 m) and supplements the Standard Controller.



PANEL-MOUNTED

This Panel-mounted Controller can be added to a compartment or any protected area. Available on all towers, this option can be used alone or with another controller.











V-MUX / CLASS 1

Operate your light tower via V-Mux or Class 1 in-cab controls, which supplement the Standard Controller and are available on all Command Light towers.

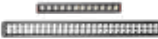
LEDs



LEDs produce long-lasting, energy-efficient lighting by passing a current through a semi-conductor rich in electrons and a semi-conductor rich in holes to produce photons, the light you see.

AC	LEDs	POWER	TOTAL WATTS	OUTPUT
FIRETECH HELIOS*	 Exclusive Command Light fixture that delivers an economical LED!	115V or 230V AC	60W	14,000 lumens
FRC RADIANT COMMAND	 Exclusive Command Light fixture that features a spot/flood combination	115V or 230V AC	120W	17,000 lumens
FRC SPECTRA	 Top/bottom flood lights with middle spot and lower diffuser	115V or 230V AC	220W	20,000 lumens
FRC SPECTRA MAX**	 Top/bottom flood lights with middle spot LED and lower diffuser	115V or 230V AC	335W	28,000 lumens
FIRETECH HIVIZ	 Knight Slim exclusive, featuring two 270-watt and two 60-watt fixtures	115V AC	60W 270W	6,500 lumens 28,500 lumens
FIRETECH SL-X-15	 More output with less power consumption	115V or 230V AC	185W	28,000 lumens
WHELEN PIONEER PLUS PFP2***	 Dual panel with flood light	115V or 230V AC	150W	20,442 lumens
WHELEN PIONEER PLUS PFP4	 Quad panel with flood light and Whelen's highest luminous output	115V or 230V AC	300W	40,884 lumens
WHELEN PIONEER PLUS PSP1	 Single panel with spot light	115V or 230V AC	75W	8,517 lumens













*An exclusive Command Light fixture. **FRC Spectra Max-S are also available upon request. *** Upgrade from standard Whelen flood to spot/flood combo upon request.

QUARTZ HALOGEN

The quartz halogen bulb is a type of incandescent bulb that has been refined to produce more light per unit of energy. The filament tube has a small amount of halogen gas in it to prevent bulb darkening and filament evaporation, which increases the bulb life while producing crisp light.

AC	QUARTZ HALOGEN	POWER	TOTAL WATTS	OUTPUT
FRC FOCUS	 Reflector redirects and focuses light	115V or 230V AC	750w	10,500 lumens
LUMENFORM	 Industrial-grade quartz halogen luminary	115V or 230V AC	500w	11,100 lumens

*** All fixtures specifications are provided by the manufacturer and are subject to change; all information is the latest available at the time of publication.

DC	LEDs	POWER	TOTAL WATTS	OUTPUT
AKRON REVEL SL	 Combines a spot / flood pattern, directing light evenly across scene	12V or 24V DC	110W	14,000 lumens
AKRON REVEL XL	 Combines a spot / flood pattern with even more lumens	12V or 24V DC	220W	28,000 lumens
FIRETECH BROW LIGHTS	 Knight Slim exclusive, featuring two 270-watt and two 60-watt fixtures	12V or 24V DC	60W 270W	6,500 lumens 28,500 lumens
FIRETECH GUARDIAN ELITE	 Produces up to 4 times the light output at half the size and cost of similar fixtures	12V or 24V DC	120W	20,500 lumens
FIRETECH HELIOS*	 Exclusive Command Light fixture that delivers an economical LED!	12V or 24V DC	60W	14,000 lumens
FIRETECH SL-X-15	 More output with less power consumption	12V or 24V DC	185W	28,000 lumens
FRC RADIANT COMMAND*	 Exclusive Command Light fixture that features a spot/flood combination	12V or 24V DC	120W	17,000 lumens
FRC SPECTRA	 Uniform flood and spot combination of super bright, white light	12V or 24V DC	220W	20,000 lumens
FRC SPECTRA MAX**	 Top/bottom flood lights with middle spot LED and lower diffuser	12V or 24V DC	230W	28,000 lumens
LIGHTFORCE HTX	 Combines 20 LEDs for flood beam + HID bulb for 1,932 yards of viewing	12V or 24V DC	150W	13,500 lumens
WHELEN PIONEER PLUS PCH1***	 Single panel with combo flood/spot and Proclera® silicone optics	12V or 24V DC	75W	10,130 lumens
WHELEN PIONEER PLUS PFH2	 Dual panel with flood Proclera® silicone optics	12V or 24V DC	150W	20,261 lumens

*An exclusive Command Light fixture. **FRC Spectra Max-S are also available upon request. *** Upgrade from standard Whelen flood to spot/flood combo upon request.

LED RETROFITS

Lengthen the lifespan of your quartz halogen tower by converting it to LED!

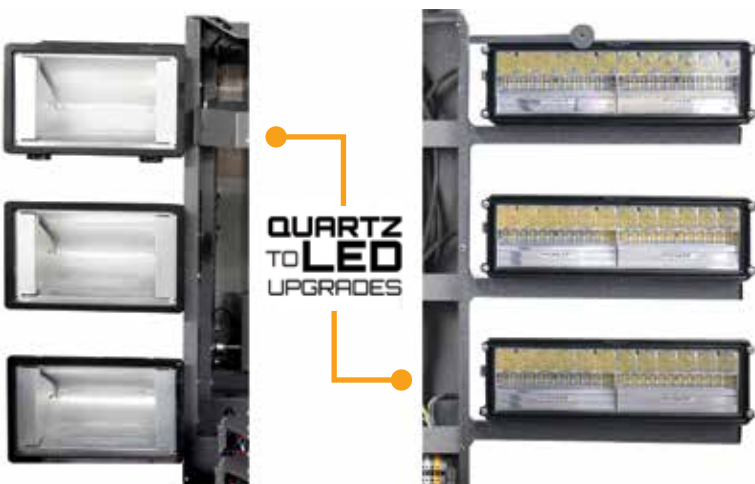

- ✓ Retrofit most in-service quartz halogen 2-, 4- and 6-head towers
- ✓ Update to the latest LED technology from FRC, Whelen and Command Light's own fixtures, the Helios and Radiant Command
- ✓ With just your Command Light serial number, we can determine if your tower can be upgraded
- ✓ Cost varies based on fixture selection, complexity of upgrade and the number of heads

SLs and KLs include new lamp trees; CLs include new lamp brackets. Note: Upgrade pricing is not valid on towers less than 1 year old.



See before-and-after footage of a Command Light LED retrofit at bit.ly/led-retrofit.

THE ONLY TRIPOD THAT LETS YOU CHOOSE:

YOUR POWER SOURCE ...

- ✓ AC POWER
- ✓ TRUCK 12V DC
- ✓ DEWALT® FLEXVOLT™
- ✓ MAKITA® XGT
- ✓ MILWAUKEE® M28

YOUR LED HEAD...

- ✓ AKRON REVELS
- ✓ FRC RADIANT COMMAND
- ✓ FRC SPECTRAS
- ✓ FIRETECH GUARDIAN ELITE
- ✓ FIRETECH HELIOS
- ✓ WHELENS
- ✓ ARROW STICKS
- ✓ MESSAGE BARS



PLUS, MEET THE NEW BATTERY-POWERED
EOS-RDL (RAPID DEPLOY LIGHT)

SEE PAGE 10 FOR BATTERY LIGHTING >

LIGHTS

BATTERY POWERED!

Command Light continues to elevate scene lighting, this time revolutionizing the mobile lighting market with the introduction of its new battery-powered EOS-RDL (Rapid Deploy Light), which joins the Trident Tripod. Both lights let crews choose their power source and favorite high-powered LED!



AC TRIPODS



FireTech
Helios



FRC
Spectra



FRC
Spectra Max



Whelen
Pioneer Plus™
PSP1



Whelen
Pioneer Plus™
PFP4

AC LEDES

AC	LIGHTING	POWER REQ.	WT.*	TOTAL OUTPUT
TXXA-FS	FRC Spectra x 1	115V or 220V AC 220W	30 lbs 13 kg	20,000 lumens
TXXA-FX	FRC Spectra Max x 1	115V or 220V AC 335W	30 lbs 13 kg	28,000 lumens
TXXA-W1	Whelen PSP1 x 1	115V or 220V AC 75W	25 lbs 11 kg	8,517 lumens
TXXA-W12	Whelen PSP1 x 2	115V or 220V AC 150W	35 lbs 16 kg	17,034 lumens
TXXA-W2	Whelen PFP2 x 1	115V or 220V AC 150W	30 lbs 13 kg	20,442 lumens
TXXA-W4	Whelen PFP4 x 1	115V or 220V AC 300W	35 lbs 16 kg	40,884 lumens
TXXA-CH	FireTech Helios x 1	115V or 220V AC 60W	30 lbs 13 kg	14,000 lumens
TXXA-CH2	FireTech Helios x 2	115V or 220V AC 120W	45 lbs 20 kg	28,000 lumens

TXX = TRIPOD HEIGHT

T40 = 40" Tripod or T50 = 50" Tripod

* Weights listed with no options.

AC POWER OPTIONS

AC OPTIONS	DESCRIPTION
L5-15	L5-15 Twist Lock in lieu of Standard 3-Prong Plug - 115V AC
L5-20	L5-20 Twist Lock in lieu of Standard 3-Prong Plug - 115V AC
L6-15*	L6-15 Twist Lock in lieu of Standard 3-Prong Plug - 230V AC

* L6-15 230V AC plugs only available with FRC and FireTech LEDs.

** Add -MB for Truck Mounting Brackets

MODEL
ORDERING
GUIDE >

AC MODELS

T50A-FS-L5-20-MB

LED Selection
A = 115 V or 220V AC
T40 = 40" Tripod; T50 = 50" Tripod
Twist Lock (LO) of 3-Prong Plug / Amp
Truck Mounting Brackets

BATTERY TRIPODS

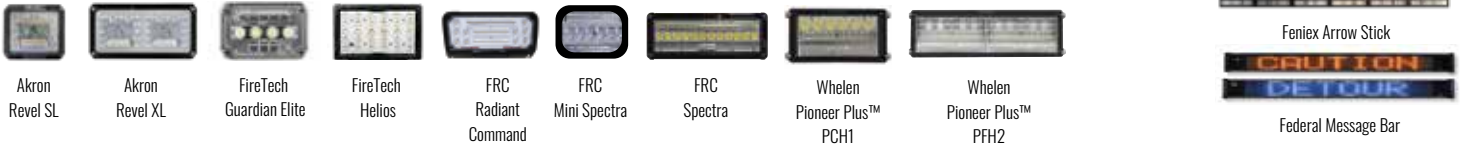

DC LEADS

DC	LIGHTING	POWER REQ.	WT.*	TOTAL OUTPUT	ESTIMATED RUN TIME **									
					DeWalt FLEXVOLT 9Ah	DeWalt FLEXVOLT 12Ah	DeWalt FLEXVOLT 15Ah	Makita XGT 4Ah	Makita XGT 5Ah	Makita XGT 8Ah	Milwaukee M28 3Ah	Milwaukee M28 5Ah	HURST® EWXT / E3™ 5Ah	HURST® EWXT / E3™ 9Ah
TXXD-AR-BX	Akron Revel SL****	110W	25 lbs 11 kg	14,000 lumens	85 minutes	110 minutes	132 minutes	75 minutes	93 minutes	135 minutes	64 minutes	102 minutes	58 minutes	88 minutes
TXXD-AX-BX	Akron Revel XL****	220W	35 lbs 16 kg	28,000 lumens	42 minutes	55 minutes	66 minutes	37 minutes	46 minutes	69 minutes	32 minutes	51 minutes	29 minutes	44 minutes
TXXD-HE-BX	FireTech Guardian Elite	120W	30 lbs 13 kg	20,500 lumens	86 minutes	114 minutes	135 minutes	76 minutes	92 minutes	136 minutes	68 minutes	107 minutes	x	x
TXXD-CH-BX	FireTech Helios	60W	30 lbs 13 kg	14,000 lumens	135 minutes	175 minutes	210 minutes	94 minutes	150 minutes	220 minutes	96 minutes	153 minutes	x	x
TXXD-FN-BX	FRC Mini Spectra	130W	35 lbs 16 kg	14,000 lumens	79 minutes	105 minutes	126 minutes	70 minutes	85 minutes	125 minutes	62 minutes	99 minutes	x	x
TXXD-FR-BX	FRC Radiant Command	120W	30 lbs 13 kg	17,000 lumens	86 minutes	114 minutes	135 minutes	76 minutes	92 minutes	132 minutes	68 minutes	107 minutes	x	x
TXXD-FS-BX	FRC Spectra	220W	30 lbs 13 kg	20,000 lumens	49 minutes	64 minutes	75 minutes	40 minutes	50 minutes	74 minutes	34 minutes	54 minutes	x	x
TXXD-W1-BX	Whelen PCH	75W	25 lbs 11 kg	10,130 lumens	145 minutes	192 minutes	225 minutes	130 minutes	160 minutes	235 minutes	105 minutes	172 minutes	x	x
TXXD-W2-BX	Whelen PFH2	150W	30 lbs 13 kg	20,261 lumens	74 minutes	96 minutes	112 minutes	65 minutes	81 minutes	122 minutes	54 minutes	86 minutes	x	x
TXXD-LB-BX	60w Fenix Light Bar***	60W Max	35 lbs 16 kg	Arrow patterns and floodlight	150 minutes	200 minutes	235 minutes	120 minutes	150 minutes	220 minutes	100 minutes	165 minutes	165 minutes	300 minutes
TXXD-FBA-BX	Amber Federal Message Bar	90W Max	35 lbs 16 kg	Digital message	100 minutes	133 minutes	155 minutes	80 minutes	100 minutes	145 minutes	67 minutes	110 minutes	110 minutes	200 minutes
TXXD-FBB-BX	Blue Federal Message Bar	90W Max	35 lbs 16 kg	Digital message	100 minutes	133 minutes	155 minutes	80 minutes	100 minutes	145 minutes	67 minutes	110 minutes	110 minutes	200 minutes

BX = DC OPTIONS

Replace BX with power designation from chart on right.

TXX = TRIPOD HEIGHT

T40 = 40" Tripod

T50 = 50" Tripod

DC LED CHART DISCLAIMERS

* Weights listed with no options. Add 5 lbs. to 50-inch tripod models.

** Reported run times based on fully charged batteries at 70° F; temperature and battery condition can impact tripod performance. Light blinks three times to warn of low-battery conditions.

*** Light/message bar run times based on floodlight pattern. Multiply minutes by 2 for average arrow patterns.

**** HURST-powered tripods are only available with Akron Revel fixtures or light/message bars.

MODEL ORDERING GUIDE

DC MODELS

T50D-W2-BD-12-SP-TP

T40 = 40" Tripod; T50 = 50" Tripod
 D = 12V DC
 LED Selection
 Battery / Charger Selection
 Battery Ah
 Shore Power Option
 Truck Power Option

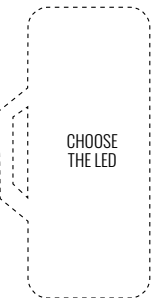

ADJUSTABLE LEG EXTENSION

BATTERY LIGHTS

DC POWER OPTIONS

DC OPTIONS*	DESCRIPTION
DELETE BX*	No Battery Capability, 12V DC-Powered Tripod ONLY
BD	Battery Option - DeWalt FLEXVOLT Ready
BD-09	DeWalt FLEXVOLT 9Ah Battery and Fast Charger
BD-12	DeWalt FLEXVOLT 12Ah Battery and Fast Charger
BD-15	DeWalt FLEXVOLT 15Ah Battery and Fast Charger
BK	Battery Option - Makita XGT Ready
BK-04	Battery Option - Makita XGT 4Ah Battery and Charger
BK-05	Battery Option - Makita XGT 5Ah Battery and Charger
BK-08	Battery Option - Makita XGT 8Ah Battery and Charger
BL or BW	Battery Option - Milwaukee REDLITHIUM Ready***
BH	Battery Option — HURST EWXT / E3 Ready ****
SP**	115V AC or 220V AC Shore Power Option - 15A Plug
TP	12V DC Truck Power Option
TP-MB	12V DC Truck Power Option + Truck Mounting Brackets with Quick Disconnect

BUNDLES	MODEL	DESCRIPTION
POWER BUNDLES	TXXD-FS-BD-12-SP	40" or 50" Tripod, 220W FRC Spectra LED x 1, DeWalt 12Ah Battery + Charger, 115V AC or 220V AC Shore Power
	TXXD-FS-BK-05-SP	40" or 50" Tripod, 220W FRC Spectra LED x 1, Makita 5Ah Battery + Charger, 115V or 220V AC Shore Power
BALANCED BUNDLES	TXXD-W2-BD-12-SP	40" or 50" Tripod, 150W Whelen PFH2 LED x 1, DeWalt 12Ah Battery and Charger, 115V or 220V AC Shore Power
	TXXD-W2-BK-05-SP	40" or 50" Tripod, 150W Whelen PFH2 LED x 1, Makita 5Ah Battery + Charger, 115V or 220V AC Shore Power
RUN-TIME BUNDLES	TXXD-CH-BD-12-SP	40" or 50" Tripod, 60W FireTech Helios LED x 1, DeWalt 12Ah Battery + Charger, 115V or 220V AC Shore Power
	TXXD-CH-BK-05-SP	40" or 50" Tripod, 60W FireTech Helios LED x 1, Makita 5Ah Battery + Charger, 115V or 220V AC Shore Power
VALUE BUNDLES	TXXD-AR-BD-09-SP	40" or 50" Tripod, 110W Akron Revel SL LED x 1, DeWalt 9Ah Battery + Charger, 115V or 220V AC Shore Power
	TXXD-AR-BK-04-SP	40" or 50" Tripod, 110W Akron Revel SL LED x 1, Makita 4Ah Battery + Charger, 115V or 220V AC Shore Power

DC POWER OPTION DISCLAIMERS:

- * Must pick 1 Battery Option or Truck Power Option.
- ** Shore Power only available in addition to a Battery Option.
- *** For M28 batteries or chargers, please see your Genesis, TNT or Weber dealer.
- **** HURST®, EWXT™/E3™ and Jaws of Life® are trademarks of HURST Jaws Of Life, Inc. HURST batteries are sold exclusively through the HURST dealer network. The HURST models are only available with Akron LEDs.

THE NEW EOS-RDL RAPID DEPLOY LIGHT



DC LEDS



Akron Revel SL FireTech Guardian Elite FRC Mini Spectra Tomar TRX6 Whelen Pioneer Plus™ PCH Vision X VL29

DC	LIGHTING	POWER REQ.	WT.*	TOTAL OUTPUT
RL11D-AR-BX	Acron Revel SL	110W	10 lbs 4.5 kg	14,000 lumens
RL11D-HE-BX	FireTech Guardian Elite	120W	13 lbs 6 kg	20,500 lumens
RL11D-FN-BX	FRC Mini Spectra	130W	11 lbs 5 kg	14,000 lumens
RL11D-W1-BX	Whelen PCH	75W	9 lbs 4 kg	10,130 lumens
RL11D-TT-BX	Tomar TRX6 x 2	60W	9 lbs 4 kg	5,520 lumens
RL11D-VV-BX	Vision X VL29 x 2	90W	9 lbs 4 kg	9,504 lumens

ESTIMATED RUN TIMES: Please reference the run times in the LED chart, left on Page 10. F or RL11D-TT-BX and RL11D-VV-BX run times, please consult the website.

* Weights listed with no options.

DC POWER OPTIONS

DC OPTIONS*	DESCRIPTION
BD	Battery Option - DeWalt FLEXVOLT Ready
BD-09	DeWalt FLEXVOLT 9Ah Battery and Fast Charger
BD-12	DeWalt FLEXVOLT 12Ah Battery and Fast Charger
BD-15	DeWalt FLEXVOLT 15Ah Battery and Fast Charger
BK	Battery Option - Makita XGT Ready
BK-04	Battery Option - Makita XGT 4Ah Battery and Charger
BK-05	Battery Option - Makita XGT 5Ah Battery and Charger
BK-08	Battery Option - Makita XGT 8Ah Battery and Charger
BL or BW	Battery Option - Milwaukee REDLITHIUM Ready***
SP**	115V or 220V AC Shore Power Option - 15A Plug

CL SERIES

TOWERS WITH 11-FOOT REACH



THE CL SERIES towers are Command Light's largest units with a reach up to 11 feet from its base. These units are designed for large apparatus and are manufactured using aircraft-grade aluminum alloy to reduce weight while adding strength. These towers can rotate 360° and tilt, raise and lower with ease to mitigate shadows in all types of situations. Unlike truck-mounted perimeter LEDs, this gives crews the ability to direct all of the usable light. A tower can even be angled to overhang the vehicle to provide operable light near the side of the apparatus.



THE CL SERIES OCTOLIGHT Meet the industry's most powerful light tower, the CL Series Octolight eight-head tower, available with FRC, FireTech or Whelen fixtures. The Whelen Pioneer Plus PFP4 fixtures provide a whopping 327,072 luminous output, while the FRC Spectra Max heads deliver combo optics with top-and-bottom flood lights, plus middle-spot LEDs for long-distance illumination.

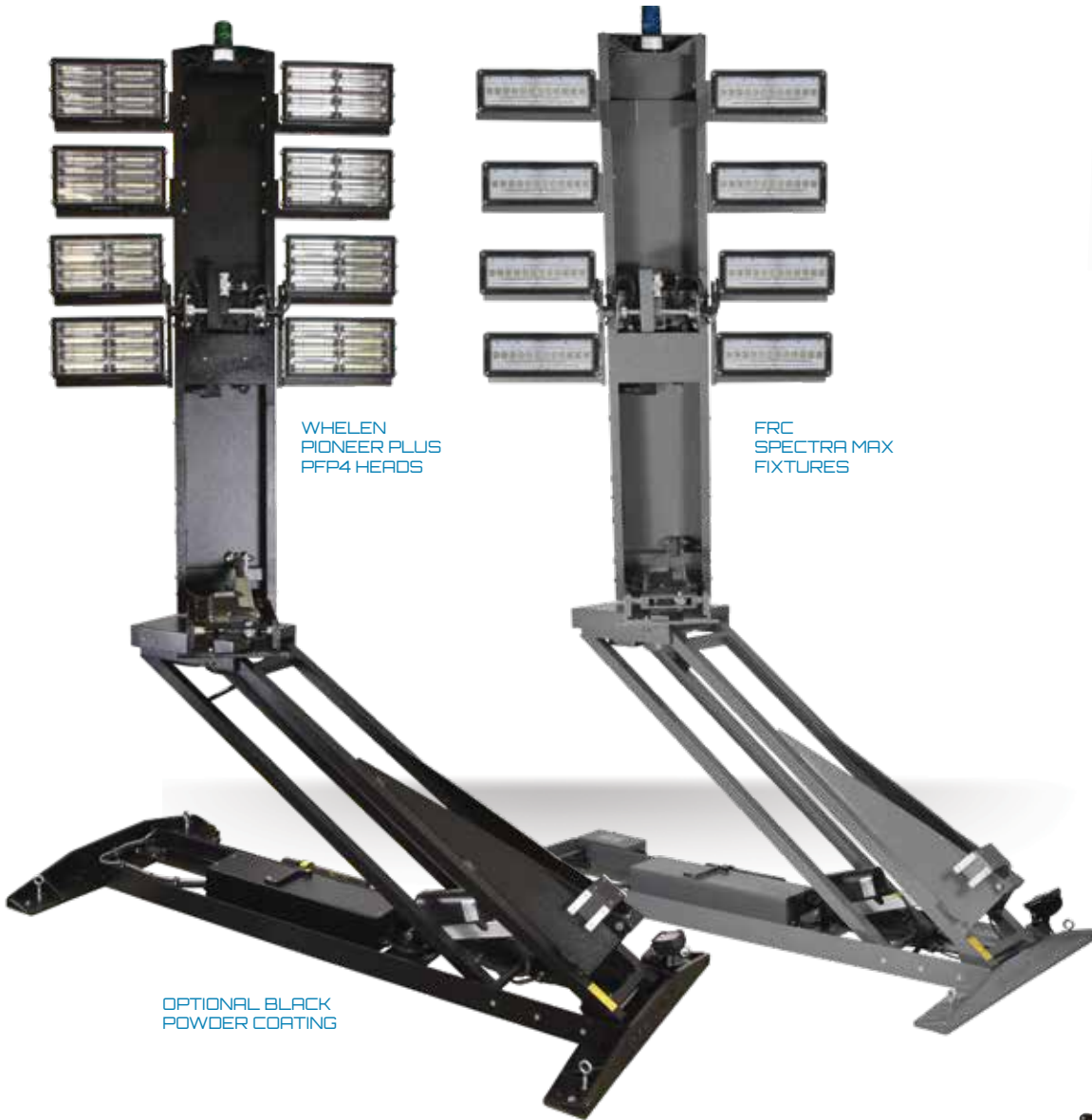

WHELEN PIONEER PLUS PFP4 HEADS

FRC SPECTRA MAX FIXTURES

OPTIONAL BLACK POWDER COATING



NESTED POSITION

OPTIONS
(SEE PAGE 5 FOR DESCRIPTIONS)



BACKLIGHT



STROBE



COLOR



CAMERA



CONTROLS

LEDs



FRC Spectra Max



Whelen Pioneer Plus PFP4

AC	LIGHTING	POWER REQUIREMENTS	OUTPUT (PER LIGHT)	TOTAL OUTPUT	HXWXD (NESTED)	HXWXD (UPRIGHT)	WT.
CL802A-FX	FRC Spectra Max 335W	115V or 230V AC 2,980W	28,000 lumens	224,000 lumens	12" x 74" x 43" 305 mm x 1,880 mm x 1,095 mm	131" x 79" x 43" 3,330 mm x 2,010 mm x 1,095 mm	325 lbs 147 kg
CL802A-W4	Whelen Pioneer Plus PFP4 300W	115V or 230V AC 2,700W	40,884 lumens	327,072 lumens	12" x 74" x 43" 305 mm x 1,880 mm x 1,095 mm	131" x 79" x 43" 3,330 mm x 2,010 mm x 1,095 mm	

CL HEAD



CL SERIES LIGHT TOWERS With an 11-foot reach, the CL Series light tower has the ability to provide even lighting across large scenes and reach over (and beyond) obstacles. These towers concentrate and precisely direct the light source, reducing shadows and intense ground-level light. The CL Series also has the ability to direct light at higher levels, aiding in mountain slope and high-rise building rescues.

OPTIONS (SEE PAGE 5 FOR DESCRIPTIONS)



LEDs

AC	LIGHTING	POWER REQUIREMENTS	OUTPUT (PER LIGHT)	TOTAL OUTPUT	HxWxD (NESTED)	HxWxD (UPRIGHT)	WT.
CL602A-HS	(6) FireTech SL-X-15 185W	115V or 230V AC 1,540W	28,000 lumens	168,000 lumens	12" x 74" x 43" 305 mm x 1,880 mm x 1,095 mm	131" x 79" x 43" 3,330 mm x 2,010 mm x 1,095 mm	325 lbs 147 kg
CL602A-FR	(6) FRC Radiant Command 120W	115V or 230V AC 1,020W	17,000 lumens	102,000 lumens	12" x 74" x 40" 305 mm x 1,880 mm x 1,015 mm	131" x 79" x 40" 3,330 mm x 2,010 mm x 1,015 mm	305 lbs 139 kg
CL602A-FS	FRC Spectra 220W	115V or 230V AC 1,620W	20,000 lumens	120,000 lumens	12" x 74" x 43" 305 mm x 1,880 mm x 1,095 mm	131" x 79" x 43" 3,330 mm x 2,010 mm x 1,095 mm	
CL602A-FX	FRC Spectra Max 335W	115V or 230V AC 2,310W	28,000 lumens	168,000 lumens	12" x 74" x 43" 305 mm x 1,880 mm x 1,095 mm	131" x 79" x 43" 3,330 mm x 2,010 mm x 1,095 mm	
CL602A-W2	Whelen Pioneer Plus PFP2 150W	115V or 230V AC 1,200W	20,442 lumens	122,652 lumens	12" x 74" x 43" 305 mm x 1,880 mm x 1,095 mm	131" x 79" x 43" 3,330 mm x 2,010 mm x 1,095 mm	
CL602A-W4	Whelen Pioneer Plus PFP4 300W	115V or 230V AC 2,100W	40,884 lumens	245,304 lumens	12" x 74" x 43" 305 mm x 1,880 mm x 1,095 mm	131" x 79" x 43" 3,330 mm x 2,010 mm x 1,095 mm	

QUARTZ HALOGEN



FRC Focus

AC	LIGHTING	POWER REQUIREMENTS	OUTPUT (PER LIGHT)	TOTAL OUTPUT	HxWxD (NESTED)	HxWxD (UPRIGHT)	WT.
CL605A-FF	FRC Focus 500W	115V or 230V AC 3,300W	10,500 lumens	63,000 lumens	12" x 74" x 41" 305 mm x 1,880 mm x 1,045 mm	131" x 79" x 41" 3,330 mm x 2,010 mm x 1,045 mm	305 lbs 139 kg
CL607A-FF	FRC Focus 750W	115V or 230V AC 4,800W	19,600 lumens	117,600 lumens	12" x 74" x 41" 305 mm x 1,880 mm x 1,045 mm	131" x 79" x 41" 3,330 mm x 2,010 mm x 1,045 mm	
CL611A-FF	FRC Focus 1,000W	230V AC 6,300W	22,000 lumens	132,000 lumens	12" x 74" x 46" 305 mm x 1,880 mm x 1,170 mm	131" x 79" x 46" 3,330 mm x 2,010 mm x 1,170 mm	
CL615A-FF	FRC Focus 1,500W	230V AC 9,300W	35,000 lumens	210,000 lumens	12" x 74" x 46" 305 mm x 1,880 mm x 1,170 mm	131" x 79" x 46" 3,330 mm x 2,010 mm x 1,170 mm	



CL SERIES

4 HEAD



OPTIONS (SEE PAGE 5 FOR DESCRIPTIONS)



* On this DC tower, amperage only allows for one of these options.



LEDS



DC	LIGHTING	POWER REQUIREMENTS	OUTPUT (PER LIGHT)	TOTAL OUTPUT	HXWXD (NESTED)	HXWXD (UPRIGHT)	WT.
CL602D-HS	(4) FireTech SL-X-15 185W	12V DC - 87 amps 1,040W	28,000 lumens	112,000 lumens	12" x 74" x 43" 305 mm x 1,880 mm x 1,095 mm	131" x 79" x 43" 3,330 mm x 2,010 mm x 1,095 mm	325 lbs 147 kg
CL602D-FR	(4) FRC Radiant Command 120W	12V DC - 65 amps 780W	17,000 lumens	68,000 lumens	12" x 74" x 40" 305 mm x 1,880 mm x 1,015 mm	131" x 79" x 40" 3,330 mm x 2,010 mm x 1,015 mm	305 lbs 139 kg
CL602D-FS	FRC Spectra 220W	12V DC - 98 amps 1,180W	20,000 lumens	80,000 lumens	12" x 74" x 43" 305 mm x 1,880 mm x 1,095 mm	131" x 79" x 43" 3,330 mm x 2,010 mm x 1,095 mm	
CL602D-FX	FRC Spectra Max 230W	12V DC - 100 amps 1,220W	28,000 lumens	112,000 lumens	12" x 74" x 43" 305 mm x 1,880 mm x 1,095 mm	131" x 79" x 43" 3,330 mm x 2,010 mm x 1,095 mm	
CL602D-W2	Whelen Pioneer Plus PFH2 150W	12V DC - 75 amps 900W	20,261 lumens	81,044 lumens	12" x 74" x 43" 305 mm x 1,880 mm x 1,095 mm	131" x 79" x 43" 3,330 mm x 2,010 mm x 1,095 mm	

KL SERIES

TOWERS WITH 7.5-FOOT REACH

THE KNIGHT SERIES, Command Light's mid-size tower, delivers a reach of nearly 7.5 feet from its base. Like the CL Series, these units are manufactured using aircraft-grade aluminum but are roughly half the weight of their taller counterpart, making these towers ideal for apparatus with limited space. The series also includes the KL Slim, a narrow tower with a small 53" x 13" footprint, perfect for tight dunnage areas or high-side aerial compartments.





NESTED POSITION

OPTIONS (SEE PAGE 5 FOR DESCRIPTIONS)



LEDs



AC	LIGHTING	POWER REQUIREMENTS	OUTPUT (PER LIGHT)	TOTAL OUTPUT	HXWXD (NESTED)	HXWXD (UPRIGHT)	WT.
KL415A-CH	FireTech Helios 60W	115V or 230V AC 660W	14,000 lumens	84,000 lumens	12" x 47" x 28" 305 mm x 1,195 mm x 710 mm	87.5" x 52" x 28" 2,225 mm x 1,320 mm x 710 mm	165 lbs 75 kg
KL415A-FR	FRC Radiant Command 120W	115V or 230V AC 1,020W	17,000 lumens	102,000 lumens	12" x 47" x 29" 305 mm x 1,195 mm x 735 mm	87.5" x 52" x 29" 2,225 mm x 1,320 mm x 735 mm	
KL415A-FS	FRC Spectra 220W	115V or 230V AC 1,620W	20,000 lumens	120,000 lumens	12" x 47" x 34" 305 mm x 1,195 mm x 865 mm	87.5" x 52" x 34" 2,225 mm x 1,320 mm x 865 mm	
KL415A-FX	FRC Spectra Max 335W	115V or 230V AC 2,310W	28,000 lumens	168,000 lumens	12" x 47" x 34" 305 mm x 1,195 mm x 865 mm	87.5" x 52" x 34" 2,225 mm x 1,320 mm x 865 mm	
KL415A-W2	Whelen Pioneer Plus PFP2 150W	115V or 230V AC 1,200W	20,442 lumens	122,652 lumens	12" x 47" x 34" 305 mm x 1,195 mm x 865 mm	87.5" x 52" x 34" 2,225 mm x 1,320 mm x 865 mm	
KL408A-W1	Whelen Pioneer Plus PSP1 75W	115V or 230V AC 750W	8,517 lumens	51,102 lumens	12" x 47" x 23" 305 mm x 1,195 mm x 585 mm	87.5" x 52" x 23" 2,225 mm x 1,320 mm x 585 mm	
DC	LIGHTING	POWER REQUIREMENTS	OUTPUT (PER LIGHT)	TOTAL OUTPUT	HXWXD (NESTED)	HXWXD (UPRIGHT)	WT.
KL415D-AR	Akron Revel SL 110W	12V DC – 80 amps 960W	14,000 lumens	84,000 lumens	12" x 47" x 23" 305 mm x 1,195 mm x 585 mm	87.5" x 52" x 23" 2,225 mm x 1,320 mm x 585 mm	165 lbs 75 kg
KL415D-CH	FireTech Helios 60W	12V DC – 55 amps 660W	14,000 lumens	84,000 lumens	12" x 47" x 28" 305 mm x 1,195 mm x 710 mm	87.5" x 52" x 28" 2,225 mm x 1,320 mm x 710 mm	
KL408D-W1	Whelen Pioneer Plus PCH1 75W	12V DC – 63 amps 750W	10,130 lumens	60,780 lumens	12" x 47" x 23" 305 mm x 1,195 mm x 585 mm	87.5" x 52" x 23" 2,225 mm x 1,320 mm x 585 mm	

QUARTZ HALOGEN



AC	LIGHTING	POWER REQUIREMENTS	OUTPUT (PER LIGHT)	TOTAL OUTPUT	HXWXD (NESTED)	HXWXD (UPRIGHT)	WT.
KL475A-FF	FRC Focus 750W	115 or 230V AC 4,800W	19,600 lumens	117,600 lumens	13" x 47" x 25" 330 mm x 1,195 mm x 635 mm	87.5" x 52" x 25" 2,225 mm x 1,320 mm x 635 mm	165 lbs 75 kg
KL450A-LF	Lumenform 500W	115 or 230V AC 3,300W	11,100 lumens	66,600 lumens	12" x 47" x 23" 305 mm x 1,195 mm x 585 mm	87.5" x 52" x 23" 2,225 mm x 1,320 mm x 585 mm	

KL SERIES

4 HEAD



OPTIONS (SEE PAGE 5 FOR DESCRIPTIONS)



* On this DC tower, amperage only allows for one of these options.

LEDs



DC	LIGHTING	POWER REQUIREMENTS	OUTPUT (PER LIGHT)	TOTAL OUTPUT	HXWXD (NESTED)	HXWXD (UPRIGHT)	WT.
KL415D-FR	FRC Radiant Command 120W	12V DC - 65 amps 780W	17,000 lumens	68,000 lumens	12" x 47" x 29" 305 mm x 1,195 mm x 735 mm	87.5" x 52" x 29" 2,225 mm x 1,320 mm x 735 mm	165 lbs 75 kg
KL415D-FS	FRC Spectra 220W	12V DC - 98 amps 1,180W	20,000 lumens	80,000 lumens	12" x 47" x 34" 305 mm x 1,195 mm x 865 mm	87.5" x 52" x 34" 2,225 mm x 1,320 mm x 865 mm	
KL415D-FX	FRC Spectra Max 230W	12V DC - 100 amps 1,220W	28,000 lumens	112,000 lumens	12" x 47" x 34" 305 mm x 1,195 mm x 865 mm	87.5" x 52" x 34" 2,225 mm x 1,320 mm x 865 mm	
KL415D-LX	Lightforce HTX LED/HID 150W	12V DC - 75 amps 900W	13,500 lumens	54,000 lumens	14" x 47" x 31" 355 mm x 1,195 mm x 790 mm	87.5" x 52" x 31" 2,225 mm x 1,320 mm x 790 mm	
KL415D-W2	Whelen Pioneer Plus PFH2 150W	12V DC - 75 amps 900W	20,261 lumens	81,044 lumens	12" x 47" x 34" 305 mm x 1,195 mm x 865 mm	87.5" x 52" x 34" 2,225 mm x 1,320 mm x 865 mm	



KNIGHT SLIM

The Knight Slim delivers the Knight Series smallest footprint, stowing flat at just 12" x 13" x 53" thanks to this narrow design, ideal for smaller to mid-size apparatus, or larger trucks with limited space. This compact tower packs a total output of 70,000 lumens thanks to FireTech fixtures.

OPTIONS (SEE PAGE 5 FOR DESCRIPTIONS)

 STROBE*
  CAMERA*
  COLOR
  CONTROLS

* On this DC tower, amperage only allows for one of these options.

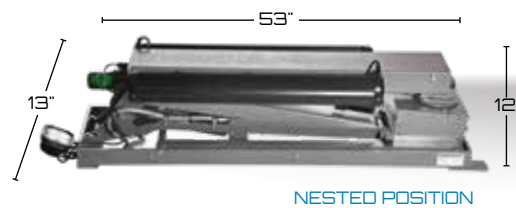

LEDs



AC	LIGHTING	POWER REQUIREMENTS	OUTPUT (PER LIGHT)	TOTAL OUTPUT	HXWXD (NESTED)	HXWXD (UPRIGHT)	WT.
KL409A-H4	(2) FireTech – 270W (2) FireTech – 60W	115V AC - 960W	270W: 28,500 60W: 6,500	70,000 lumens	12" x 53" x 13" 305 mm x 1,350 mm x 330 mm	87.5" x 53" x 13" 2,225 mm x 1,350 mm x 330 mm	165 lbs 75 kg
DC	LIGHTING	POWER	OUTPUT (PER LIGHT)	TOTAL OUTPUT	HXWXD (NESTED)	HXWXD (UPRIGHT)	WT.
KL409D-H4	(2) FireTech – 270W (2) FireTech – 60W	12V DC - 960W	270W: 28,500 60W: 6,500	70,000 lumens	12" x 53" x 13" 305 mm x 1,350 mm x 330 mm	87.5" x 53" x 13" 2,225 mm x 1,350 mm x 330 mm	165 lbs 75 kg

* Knight Slim requires 18" x 7" x 5" electrical box (mounted nearby).

SL SERIES

SL SERIES

4

HEAD

TOWERS WITH 4.5- TO 6.5-FOOT REACH

THE SHADOW SERIES are Command Light's most compact units when space is at a premium. These units have a reach of more than 4 feet from its base (or 6.5' with optional 80" arm), weigh approximately 65 lbs, and are still manufactured using aircraft-grade aluminum alloy for strength. Thanks to this compact size, these units can fit on SUVs, vans and pickup trucks, all the while featuring 355° of rotation.



SEE PAGE 18
FOR INFO ON THE
ABOVE TRAFFIC
LIGHT BAR ADDITION

OPTIONS
(SEE PAGE 5 FOR DESCRIPTIONS)



BACKLIGHT



STROBE



COLOR



CAMERA



CONTROLS



LONG ARM

LEDs

QUESTIONS? CUSTOM TOWER INQUIRIES?
CONTACT US AT INFO@COMMANDLIGHT.COM.



AC/DC	LIGHTING	POWER REQUIREMENTS	OUTPUT (PER LIGHT)	TOTAL OUTPUT	HXWXD (NESTED)	HXWXD (UPRIGHT)	WT.
SL442A-CH	FireTech Helios 60W	12V DC + 115V or 230V AC 420W	14,000 lumens	56,000 lumens	8" x 54" x 28" 205 mm x 1,375 mm x 710 mm	55" x 36" x 28" 1,395 mm x 915 mm x 710 mm	75 lbs 35 kg
SL442A-FR	FRC Radiant Command 120W	12V DC + 115V or 230V AC 1,060W	17,000 lumens	68,000 lumens	8" x 54" x 28" 205 mm x 1,375 mm x 710 mm	55" x 36" x 28" 1,395 mm x 915 mm x 710 mm	
SL442A-FS	FRC Spectra 220W	12V DC + 115V or 230V AC 1,060W	20,000 lumens	80,000 lumens	8" x 54" x 34" 205 mm x 1,375 mm x 865 mm	55" x 36" x 34" 1,395 mm x 915 mm x 865 mm	
SL442A-FX	FRC Spectra Max 335W	12V DC + 115V or 230V AC 1,520W	28,000 lumens	112,000 lumens	8" x 54" x 34" 205 mm x 1,375 mm x 865 mm	55" x 36" x 34" 1,395 mm x 915 mm x 865 mm	
SL442A-W1	Whelen PSP1 75W	12V DC + 115V or 230V AC 480W	8,517 lumens	34,068 lumens	8" x 54" x 22" 205 mm x 1,375 mm x 560 mm	55" x 36" x 22" 1,395 mm x 915 mm x 560 mm	
SL442A-W2	Whelen Pioneer Plus PFP2 150W	12V DC + 115V or 230V AC 780W	20,442 lumens	81,768 lumens	8" x 54" x 33" 205 mm x 1,375 mm x 835 mm	55" x 36" x 33" 1,395 mm x 915 mm x 835 mm	
DC	LIGHTING	POWER REQUIREMENTS	OUTPUT (PER LIGHT)	TOTAL OUTPUT	HXWXD (NESTED)	HXWXD (UPRIGHT)	WT.
SL442D-AR	Akron Revel SL 110W	12V DC – 80 amps 960W	14,000 lumens	56,000 lumens	8" x 54" x 34" 205 mm x 1,375 mm x 865 mm	55" x 36" x 34" 1,395 mm x 915 mm x 865 mm	75 lbs 35 kg
SL442D-CH	FireTech Helios 60W	12V DC – 35 amps 420W	14,000 lumens	56,000 lumens	8" x 54" x 28" 205 mm x 1,375 mm x 710 mm	55" x 36" x 28" 1,395 mm x 915 mm x 710 mm	
SL442D-FR	FRC Radiant Command 120W	12V DC – 55 amps 660W	17,000 lumens	68,000 lumens	8" x 54" x 28" 205 mm x 1,375 mm x 710 mm	55" x 36" x 28" 1,395 mm x 915 mm x 710 mm	
SL442D-FS	FRC Spectra 220W	12V DC – 90 amps 1,060W	20,000 lumens	80,000 lumens	8" x 54" x 34" 205 mm x 1,375 mm x 865 mm	55" x 36" x 34" 1,395 mm x 915 mm x 865 mm	
SL442D-FX	FRC Spectra Max 230W	12V DC – 92 amps 1,100W	28,000 lumens	112,000 lumens	8" x 54" x 34" 205 mm x 1,375 mm x 865 mm	55" x 36" x 34" 1,395 mm x 915 mm x 865 mm	
SL442D-LX	Lightforce HTX LED/HID 150W	12V DC – 65 amps 780W	13,500 lumens	54,000 lumens	8" x 56" x 23" 203 mm x 1,422 mm x 585 mm	57" x 46" x 23" 1,448 mm x 1,169 mm x 585 mm	
SL442D-W1	Whelen Pioneer Plus PCH1 75W	12V DC* – 40 amps 480W	10,130 lumens	40,520 lumens	8" x 54" x 22" 205 mm x 1,375 mm x 560 mm	55" x 36" x 22" 1,395 mm x 915 mm x 560 mm	
SL442D-W2	Whelen Pioneer Plus PFH2 150W	12V DC* – 65 amps 780W	20,261 lumens	81,044 lumens	8" x 54" x 33" 205 mm x 1,375 mm x 835 mm	55" x 36" x 33" 1,395 mm x 915 mm x 835 mm	

QUARTZ HALOGEN



AC/DC	LIGHTING	POWER REQUIREMENTS	OUTPUT (PER LIGHT)	TOTAL OUTPUT	HXWXD (NESTED)	HXWXD (UPRIGHT)	WT.
SL447A-FF	FRC Focus 750W	12V DC + 115V or 230V AC 3,180W	19,600 lumens	78,400 lumens	8" x 54" x 23" 205 mm x 1,375 mm x 585 mm	49.5" x 52" x 23" 1,260 mm x 1,320 mm x 585 mm	70 lbs 32 kg
SL445A-LF	Lumenform 500W	12V DC + 115V or 230V AC 2,180W	11,100 lumens	44,400 lumens	8" x 54" x 22" 205 mm x 1,375 mm x 560 mm	55" x 36" x 22" 1,395 mm x 915 mm x 560 mm	

SL SERIES

TOWERS WITH 4.5- TO 6.5-FOOT REACH

HEAD



OPTIONS (SEE PAGE 5 FOR DESCRIPTIONS)



STROBE



COLOR



CAMERA



CONTROLS



LONG ARM



FireTech Helios



FRC Radiant Command

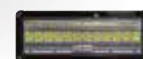

FRC Spectra



FRC Spectra Max



Whelen Pioneer Plus™ PCH1



Whelen Pioneer Plus™ PFH2



Whelen Pioneer Plus™ PFP2

LEDs

AC/DC	LIGHTING	POWER REQUIREMENTS	OUTPUT (PER LIGHT)	TOTAL OUTPUT	HXWXD (NESTED)	HXWXD (UPRIGHT)	WT.
SL422A-CH	FireTech Helios 60W	12V DC + 115V or 230V AC 300W	14,000 lumens	28,000 lumens	8" x 54" x 28" 205mm x 1,375 mm x 710 mm	55" x 36" x 28" 1,395 mm x 915 mm x 710 mm	65 lbs 32 kg
SL422A-FR	FRC Radiant Command 120W	12V DC + 115V or 230V AC 420W	17,000 lumens	34,000 lumens	8" x 54" x 28" 205 mm x 1,375 mm x 710 mm	55" x 36" x 28" 1,395 mm x 915 mm x 710 mm	
SL422A-FS	FRC Spectra 220W	12V DC + 115V or 230V AC 620W	20,000 lumens	40,000 lumens	8" x 54" x 34" 205mm x 1,375 mm x 865 mm	55" x 36" x 34" 1,395 mm x 915 mm x 865 mm	
SL422A-FX	FRC Spectra Max 335W	12V DC + 115V or 230V AC 850W	28,000 lumens	56,000 lumens	8" x 54" x 34" 205mm x 1,375 mm x 865 mm	55" x 36" x 34" 1,395 mm x 915 mm x 865 mm	
SL422A-W2	Whelen Pioneer Plus PFP2 150W	12V DC + 115V or 230V AC 480W	20,442 lumens	40,884 lumens	8" x 54" x 33" 205mm x 1,375 mm x 840 mm	55" x 36" x 33" 1,395 mm x 915 mm x 840 mm	
DC	LIGHTING	POWER	OUTPUT (PER LIGHT)	TOTAL OUTPUT	HXWXD (NESTED)	HXWXD (UPRIGHT)	WT.
SL422D-FR	FRC Radiant Command 120W	12V DC - 35 amps 420W	17,000 lumens	34,000 lumens	8" x 54" x 28" 205 mm x 1,375 mm x 710mm	55" x 36" x 28" 1,395 mm x 915 mm x 710 mm	65 lbs 30 kg
SL422D-FS	FRC Spectra 220W	12V DC - 42 amps 620W	20,000 lumens	40,000 lumens	8" x 54" x 34" 205 mm x 1,375 mm x 865 mm	55" x 36" x 34" 1,395 mm x 915 mm x 865 mm	
SL422D-FX	FRC Spectra Max 230W	12VDC - 54 amps 640W	28,000 lumens	56,000 lumens	8" x 54" x 34" 205mm x 1,375 mm x 865 mm	55" x 36" x 34" 1,395 mm x 915 mm x 865 mm	
SL422D-W1	Whelen Pioneer Plus PCH1 75W	12V DC* - 20 amps 330W	10,130 lumens	20,260 lumens	8" x 54" x 22" 205 mm x 1,375 mm x 560 mm	55" x 36" x 22" 1,395 mm x 915 mm x 560 mm	
SL422D-W2	Whelen Pioneer Plus PFH2 150W	12V DC* - 35 amps 480W	20,261 lumens	40,522 lumens	8" x 54" x 33" 205 mm x 1,375 mm x 840 mm	55" x 36" x 33" 1,395 mm x 915 mm x 840 mm	

QUARTZ HALOGEN



FRC Focus

AC/DC	LIGHTING	POWER REQUIREMENTS	OUTPUT (PER LIGHT)	TOTAL OUTPUT	HXWXD (NESTED)	HXWXD (UPRIGHT)	WT.
SL428A-FF	FRC Focus 1,000W	12V DC + 230V AC 2,180W	22,000 lumens	44,000 lumens	8" x 54" x 34" 205 mm x 1,375 mm x 865 mm	55" x 36" x 34" 1,395 mm x 915 mm x 865 mm	65 lbs 30 kg
SL429A-FF	FRC Focus 1,500W	12VDC + 230V AC 3,180W	35,000 lumens	70,000 lumens	8" x 54" x 34" 205 mm x 1,375 mm x 865 mm	55" x 36" x 34" 1,395 mm x 915 mm x 865 mm	

TOWERS WITH 3.5-FOOT REACH



STRAIGHT SHADOW

The Straight Shadow is Command Light's most economical solution in maintaining efficient scene lighting. Featuring only elevated capabilities (and not rotation), this unit offers a 3.5' reach from its base. The Straight Shadow can also be easily modified to elevate cameras and antennas.

OPTIONS (SEE PAGE 5 FOR DESCRIPTIONS)



STROBE



COLOR



CONTROLS



2-, 3- AND 4-HEAD CONFIGURATIONS



FRC Radiant Command FireTech Helios Whelen Pioneer Plus™ PFH2 Whelen Pioneer Plus™ PFP2

LEDs

AC/DC	LIGHTING	POWER REQUIREMENTS	OUTPUT (PER LIGHT)	TOTAL OUTPUT	HXWXD (NESTED)	HXWXD (UPRIGHT)	WT.
SS322A-CH	(2) FireTech Helios 60W	12V DC + 115V or 230V AC 240W	14,000 lumens	28,000 lumens	9" x 42" x 30" 230 mm x 1,065 mm x 765 mm	43" x 45" x 30" 1,092 mm x 1,145 mm x 765 mm	45 lbs 20 kg
SS322A-FR	(2) FRC Radiant Command 120W	12V DC + 115V or 230V AC 360W	17,000 lumens	34,000 lumens	9" x 42" x 30" 230 mm x 1,065 mm x 765 mm	43" x 45" x 30" 1,092 mm x 1,145 mm x 765 mm	
SS322A-W2	(2) Whelen PFP2 150W	12V DC + 115V or 230V AC 400W	20,442 lumens	40,884 lumens	9" x 42" x 30" 230 mm x 1,070 mm x 765 mm	42.5" x 45" x 30" 1,080 mm x 1,145 mm x 765 mm	
DC	LIGHTING	POWER REQUIREMENTS	OUTPUT (PER LIGHT)	TOTAL OUTPUT	HXWXD (NESTED)	HXWXD (UPRIGHT)	WT.
SS322D-CH	(2) FireTech Helios 60W	12V DC – 20 amps 240W	14,000 lumens	28,000 lumens	9" x 42" x 30" 230 mm x 1,070 mm x 765 mm	43" x 45" x 30" 1,092 mm x 1,145 mm x 765 mm	45 lbs 20 kg
SS322D-FR	(2) FRC Radiant Command	12V DC – 30 amps 360W	17,000 lumens	34,000 lumens	9" x 42" x 30" 230 mm x 1,065 mm x 765 mm	43" x 45" x 30" 1,092 mm x 1,145 mm x 765 mm	
SS322D-W2	(2) Whelen Pioneer Plus PFH2 - 150W	12V DC – 34 amps 420W	20,261 lumens	40,522 lumens	8" x 42" x 30" 205 mm x 1,070 mm x 765 mm	43" x 45" x 30" 1,092 mm x 1,145 mm x 765 mm	

QUARTZ HALOGEN



Lumenform

AC/DC	LIGHTING	POWER	OUTPUT (PER LIGHT)	TOTAL OUTPUT	HXWXD (NESTED)	HXWXD (UPRIGHT)	WT.
SS335A-LF	(3) Lumenform 500W	12V DC + 115V or 230V AC 1,620W	11,100 lumens	33,300 lumens	9" x 42" x 26" 230 mm x 1,065 mm x 660 mm	42.5" x 44.75" x 26" 1,080 mm x 1,135 mm x 660 mm	40 lbs 18 kg
SS345A-LF	(4) Lumenform 500W	12V DC + 115V or 230V AC 2,120W	11,100 lumens	44,400 lumens	8" x 42" x 25" 205 mm x 1,065 mm x 635 mm	44" x 44.75" x 25" 1,120 mm x 1,135 mm x 635 mm	45 lbs 20 kg

SL SERIES

STOWS FLAT AT 8" X 11" X 63"

CONTINUED ...

WE PUT OUR SLIM ON A DIET. THE RESULT ...

OUR NARROWEST TOWER YET!

SHADOW SLIM

Our narrowest tower yet! This tower takes the popular 7.5' Knight Slim and condenses our already-narrow footprint into the Shadow Series' 4.5' design. The SL Slim stows flat at just 8"x11"x63" while packing an output of 57,000 lumens thanks to FireTech fixtures.



OPTIONS (SEE PAGE 5 FOR DESCRIPTIONS)



STROBE*



CAMERA*



COLOR



CONTROLS

* On this DC tower, amperage only allows for one of these options.



FireTech 270w

AC	LIGHTING	POWER	OUTPUT (PER LIGHT)	TOTAL OUTPUT	HXWXD (NESTED)	HXWXD (UPRIGHT)	WT.
SL423A-H2	(2) FireTech - 270W	115V AC - 720W	28,500 lumens	57,000 lumens	8" x 63" x 11" 605 mm x 1,600 mm x 280mm	66" x 42" x 11" 1,675 mm x 1,600 mm x 280 mm	65 lbs 35 kg
DC	LIGHTING	POWER	OUTPUT (PER LIGHT)	TOTAL OUTPUT	HXWXD (NESTED)	HXWXD (UPRIGHT)	WT.
SL423D-H2	(2) FireTech - 270W	12V DC - 720W	28,500 lumens	57,000 lumens	8" x 63" x 11" 605 mm x 1,600 mm x 280mm	66" x 42" x 11" 1,675 mm x 1,600 mm x 280 mm	65 lbs 35 kg



Z-LIFT

LIGHT BAR ELEVATION



C-LITE

COMPACT LIGHTING

THE C-LITE is a versatile unit that boasts a LED spotlight/floodlight combo, creating a concentrated beam that allows the operator to illuminate areas not typically reached by fixed lights. The C-Lite has the ability to tilt up to 120° and even rotate with an optional platform. This unit's small, lightweight design can be mounted vertically or horizontally, perfect for aerial tip illumination, command vehicle lighting and utility industry applications, like farming, ranching, towing, maintenance and more.

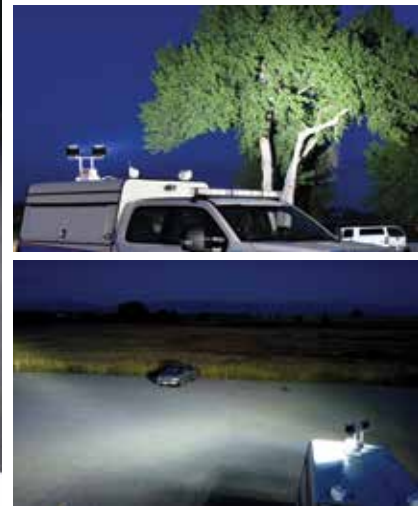

OPTIONS



CONTROLS
(PANEL MOUNTED
OR WIRELESS)



MANUAL OR
ELECTRIC
ROTATION

LEDs



FireTech Helios

FRC Radiant Command

FRC Spectra

FRC Mini Spectra

Whelen Pioneer Plus™ PCH1

DC	LIGHTING	POWER REQUIREMENTS	OUTPUT (PER LIGHT)	TOTAL OUTPUT	HXWXD (NESTED)	HXWXD (UPRIGHT)	WT.
CD113D-CH	(1) FireTech Helios 60W	12V DC - 12 amps 140W	14,000 lumens	14,000 lumens	9" x 12" x 19" 230 mm x 305 mm x 485 mm	21" x 12" x 19" 535 mm x 355 mm x 485 mm	35 lbs 16 kg
CD113D-FR	(1) FRC Radiant Command 120W	12V DC - 17 amps 200W	17,000 lumens	17,000 lumens	9" x 12" x 19" 230 mm x 305 mm x 485 mm	21" x 12" x 19" 535 mm x 305 mm x 485 mm	30 lbs 13 kg
CD113D-FS	(1) FRC Spectra 220W	12V DC - 25 amps 300W	20,000 lumens	20,000 lumens	9" x 14" x 19" 230 mm x 355 mm x 485 mm	21" x 14" x 19" 535 mm x 355 mm x 485 mm	
CD128D-FN	(2) FRC Mini Spectra 130W	12V DC - 29 amps 340W	14,000 lumens	28,000 lumens	9" x 26" x 19" 230 mm x 660 mm x 485 mm	21" x 26" x 19" 535 mm x 660 mm x 485 mm	
CD127D-W1	(2) Whelen Pioneer Plus PCH1 75W	12V DC - 20 amps 230W	10,130 lumens	20,260 lumens	9" x 19" x 19" 230 mm x 485 mm x 485 mm	21" x 19" x 19" 510 mm x 485 mm x 485 mm	

THE Z-LIFT Improve visibility by elevating your vehicle's warning lights above the roofline with Command Light's Z-Lift. This lift includes an umbilical remote with auto-deploy and auto-park feature. With the press of a button, the Z-Lift elevates the lightbar 40" high in 10 seconds, auto deploying at a straight angle. The operator can then rotate 45° or 90° (left and right) to position the lightbar toward traffic.



See the Z-Lift in action at commandlight.com/z-lift.

DC	POWER REQUIREMENTS	HXWXD (NESTED)	HXWXD (UPRIGHT)	WT.
Z-LIFT	12V DC - 17 amps 200W	6" x 22" x 47" 155 mm x 560 mm x 1,195 mm	43" x 22" x 75" 1,095 mm x 560 mm x 1,905 mm	62 lbs 28 kg



TRAFFIC FLOW BOARDS With rotational capabilities and multiple arrow patterns, Command Light's Traffic Flow Boards improve on-scene visibility and responder safety. Available in eight different models (based on deployment and traffic pattern), these units conserve space when stowed, while the versatile mounting system gives crews the ability to select various boards to conform to department requirements. Each model comes with standard rotation, giving crews the ability to position traffic advisory arrows toward traffic to maximize effectiveness during blocking modes.

DC	MOVEMENT	TRAFFIC PATTERN	POWER REQUIREMENTS	HXWXD (NESTED)	HXWXD (UPRIGHT)	WT.
TFB-V7	Vertical pop-up, recessed in apparatus	Greatest variety of traffic patterns	12V DC - 19 amps	43" x 64" x 13" 1,095 mm x 1,625 mm x 330 mm	75" x 64" x 13" 1,905 mm x 1,625 mm x 330 mm	220 lbs 100 kg
TFB-H7	Fold-down design	Greatest variety of traffic patterns	12V DC - 28 amps	16" x 60" x 46" 410 mm x 1,525 mm x 1,170 mm	44" x 60" x 66" 1,120 mm x 1,525 mm x 1,680 mm	150 lbs 68 kg
TFB-V5	Vertical pop-up, recessed in apparatus	Essential traffic patterns	12V DC - 17 amps	28" x 44" x 13" 715 mm x 1,120 mm x 330 mm	43" x 44" x 13" 1,095 mm x 1,120 mm x 330 mm	150 lbs 68 kg
TFB-H5	Fold-down design	Essential traffic patterns	12V DC - 17 amps	8" x 48" x 40" 205 mm x 1,220 mm x 1,110 mm	52" x 70" x 40" 1,325 mm x 1,780 mm x 1,020 mm	80 lbs 36 kg
TFB-CL5	Fold-down design, mounted to a CL Series tower	Essential traffic patterns	12V DC - 10 amps + tower requirements	Variable based on tower selection	Variable based on tower selection	28 lbs + tower
TFB-SL3	Fold-down design, mounted to a Shadow Series tower	Directional light bar	12V DC - 5 amps + tower requirements	Variable based on tower selection	Variable based on tower selection	14 lbs + tower
TFB-HM2	Horizontal fold-down ± 45° rotation	2-lines of text or arrows	12V DC - 27 amps 325w	16" x 73" x 52" 405mm x 1,855mm x 1,320mm	50" x 75" x 61" 1,270mm x 1,905mm x 1,550mm	220 lbs 100 kg
TFB-HM3	Horizontal fold-down ± 45° rotation	3-lines of text or arrows	12V DC - 38 amps 450w	16" x 73" x 66" 405mm x 1,855mm x 1,675mm	64" x 75" x 61" 1,625mm x 1,905 mm x 1,550 mm	240 lbs 110 kg

CHOOSING A FLOWBOARD

1 SELECT THE FLOW BOARD PROFILE

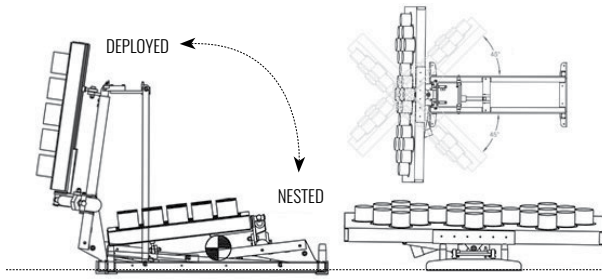

FOLD-DOWN DESIGN (H MODELS)

The H Model features a fold-down design that mounts to the apparatus to create a low-profile. Once deployed, the flow board can be rotated toward oncoming traffic.



VERTICAL POP-UP (V MODELS)

The V model's patented motion (US Patent #8638209) creates the lowest-possible profile with this vertical pop-up design that recesses into the apparatus.

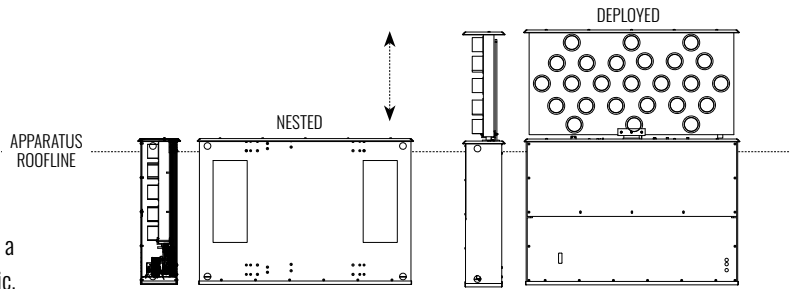

2 SELECT A TRAFFIC PATTERN



7 SERIES

The 7 Series offers the greatest variety of traffic patterns and can be deployed via the fold-down design or the vertical pop-up design.

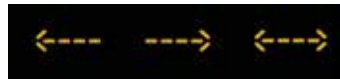

5 SERIES

The 5 Series offers essential traffic patterns in a lighter design. The board can be deployed via the fold-down design or the vertical pop-up design.



3 SERIES

The 3 Series features a light bar that provides a pulsing movement to guide traffic. The light bar mounts to the top of a SL Series light tower.



MESSAGE BOARD

Our Message Board Series provides up to three lines of programmed messaging, digital graphics and arrow patterns on a 66" wide x 28" high (2-line) or 42" high (3-line) digital screen.

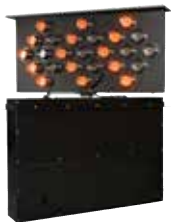

TFB-V7



TFB-H7



TFB-H5



TFB-V5



TFB-SL3



TFB-HM2 (2-line message board)
TFB-HM3 (3-line message board)

This board can also be mounted to a CL Series tower (TFB-CL5).

TFB-CL5



COMMAND LIGHT



COMMANDLIGHT.COM | 800.797.7974 | 3842 REDMAN DR. FORT COLLINS CO 80524

See a Command Light representative or authorized dealer for details. All information in this brochure is the latest available at the time of publication. Printed in the USA. 2.5K 0224 ©2024 Command Light