



PUBLIC SAFETY SPEC GUIDE  
JOTTOPUBLICSAFETY.COM

# TSP

**TOTAL SOLUTIONS PROVIDER**



## WHY JOTTO DESK?.....

VEHICLE PARTITIONS	4-5
SINGLE CELLS	6-7
CONSOLES	8
COMPUTER MOUNTS	9
GUN RACKS	10
GREEN PLUS CERTIFIED	11

## SHOP BY VEHICLE...

DODGE CHARGER	12-15	ADDITIONAL VEHICLES	36-37
FORD POLICE INTERCEPTOR SEDAN	16-19	STANDARD CONSOLES	38-39
FORD POLICE INTERCEPTOR UTILITY	20-23	FLOORPLATES	40
CHEVY TAHOE	24-27	TRUCK BED/SUV CARGO SLIDES	41
CHEVY CAPRICE	28-31	GUN RACKS	42-43
CHEVY IMPALA	32-35	KODIAK MOBILE DOCKING STATIONS	44-46

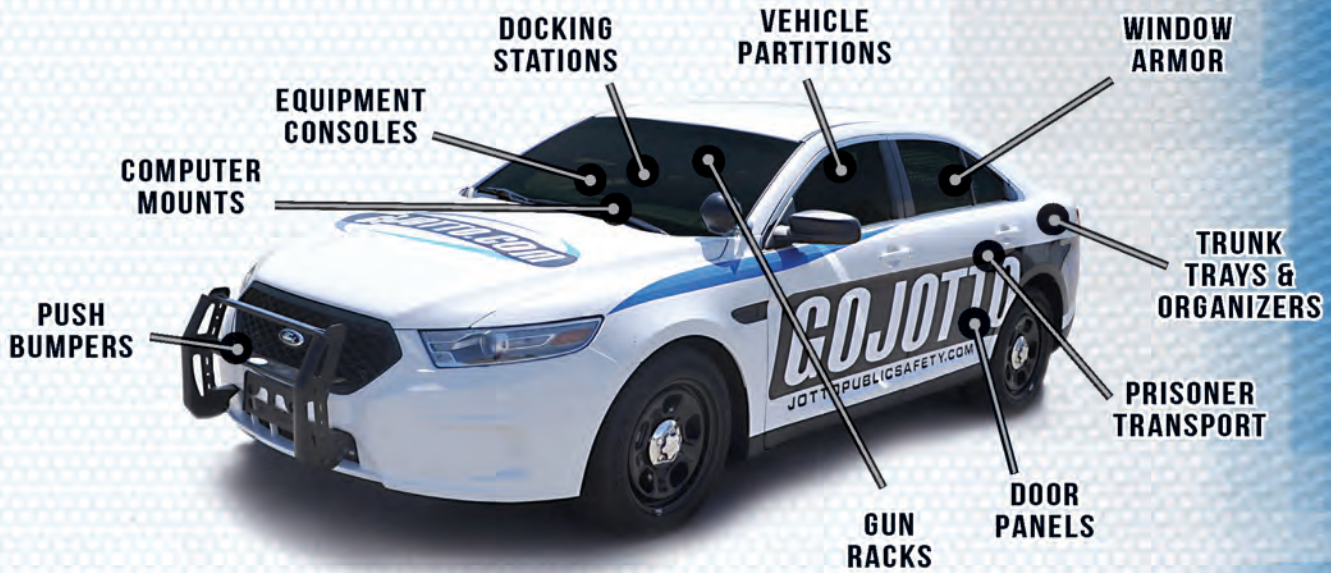

**TSP** - As the leading **Total Solutions Provider** in the Public Safety market, Jotto Desk continues to redefine the right solutions for helping public safety workforces perform their jobs safely and effectively. Since 1994, Jotto Desk has risen to become the first, **“Everything But Lights”** equipment manufacturer for public safety and homeland security.

Jotto Desk’s premier partner network enjoys the best single source of high quality products from vehicle partitions, prisoner seating, window armor/door panels, gun racks, duty gear and trunk organizers to push bumpers, skid plates and trunk trays to Mil-Spec tested intelligent docking stations, laptop mounts, equipment consoles and SUV/truck bed cargo slides. We’re committed to the **“Total”** picture and focus on designing products that interact and work well with each other. The result is peace of mind for the officer.

Jotto Desk continues to redefine the mobile workspace and expand its’ portfolio of high quality solutions and ability to deliver maximum value to you. Our reputation as a company of innovative designs, ideas and solutions allow us to emphasize the **S** in **TSP**. It isn’t just one product... it is a **“Solution”** as a result of a need or a problem brought to us by our strategic partners and agency customers. If you have a need or seek an answer – we have the **Solution**, not just a product.



James Elmore ext. 6493  
National Sales Manager  
- Public Safety -  
JELMORE@JOTTODESK.COM



**CUSTOMER SERVICE**

Johnny Knipe ext. 6406  
Public Safety Sales Manager  
- East Region -  
JKNIPE@JOTTODESK.COM



**PHONE: 877.455.6886**

Wayne Weiser ext. 6458  
Public Safety Sales Manager  
- West Region -  
WWEISER@JOTTODESK.COM

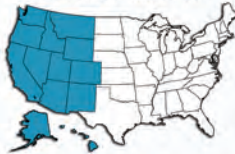

**FAX: 479.936.8620**

Rodney Weyer ext. 6490  
Public Safety Sales Manager  
- South Region -  
RWWEYER@JOTTODESK.COM



**EMAIL: CUSTOMERSVC@JOTTODESK.COM**

Kymerly Burt ext. 6474  
Public Safety Sales Manager  
- Central Region -  
KYMBERLY@JOTTODESK.COM





# WHY JOTTO DESK

# VEHICLE PARTITIONS



HIGH SECURITY/HIGH VISIBILITY WINDOW

**PATENT PENDING**



FULL WINDOW W/ SAFETY WIRE

## SPACE CREATOR VEHICLE PARTITION

Jotto Desk was the first to design the Patent Pending Space Creator Partition, which features the Bidirectional Recessed Housing (BDRH). This innovative partition solution transforms previously unusable space to create additional leg room behind the front passenger seat. This design creates unparalleled leg room for even large prisoners while maintaining excellent use of officer seat for complete comfort. There is also plenty of room for a console, gun rack and printer.



## HIGH SECURITY/HIGH VISIBILITY WINDOW

*A High Security/High Visibility (HS/HV) Window gives officers the best of both worlds - tremendous sight lines, whether looking out the rearview or turning around. The 4"H x 11"W window allows for communication or passing of information but there won't be anyone that will squeeze through this opening. If a prisoner spits/bleeds/smears the window - it is still easily cleanable...not so with "expanded metal".*

*The HS/HV window increases the visible area by a whopping 41% vs. older style windows. When someone sits in the drivers seat and looks through the rearview mirror for the first time, the natural reaction is to turn and look to see if a partition is installed...because the view is so clear.*



## STRENGTH BY DESIGN

*The Patent Pending Space Creator Partition by Jotto Desk, first introduced over a year ago, creates room where none existed. The unique design maximizes the integrity and adds strength to the "hoop design" by continuing all the way to the floor, providing maximum protection.*

*High winds blew a large pine tree onto this vehicle near Eufaula, Alabama. The Space Creator Partition design, in which the hoop goes all the way to the floor, was installed in the car and proved its strength by preventing the car from being totaled. The roof was quickly fixed and the car was soon back in service.*



SPACE CREATOR PARTITION STRENGTH BY DESIGN IN ACTION.

**TSP**  
TOTAL SOLUTIONS PROVIDER!

## FLAT PANEL VEHICLE PARTITION

The Jotto Desk Flat Panel Vehicle Partition features a flat cover panel. Two window options to choose from.



FULL WINDOW  
W/SAFETY WIRE



HIGH SECURITY/HIGH  
VISIBILITY WINDOW

8 7 7 . 4 5 5 . 6 8 8 6



THE NEW SPACE CREATOR MAX PARTITION FOR THE PI SEDAN CREATES INCREASED ROOM FOR PRISONERS THAT ARE SECURED ON THE PASSENGER SIDE AND THE DRIVER SIDE OF VEHICLE.





# WHY JOTTO DESK

# SINGLE CELL

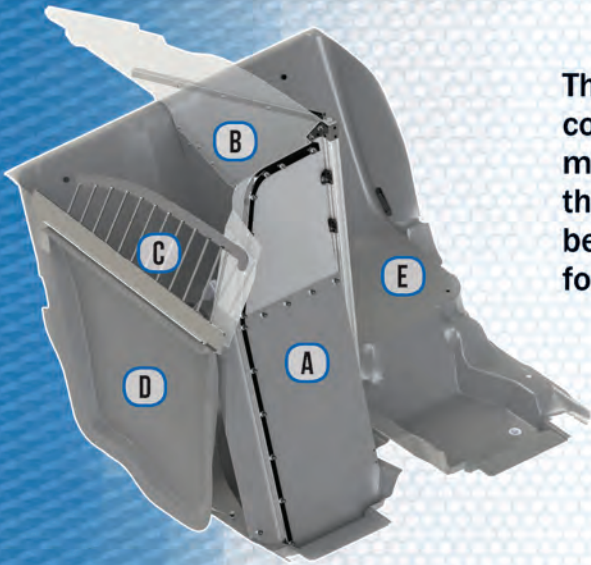

The "next generation" in prisoner containment helps to create even more room for a prisoner, provides the ultimate in driver comfort and has been designed from the ground up for ease of installation and cleaning.

## AVAILABLE FOR:

**PI SEDAN**  
**PI UTILITY**  
**CHARGER**  
**CAPRICE**  
**TAHOE**

## SINGLE CELL FOR SEDANS INCLUDES:

- Ⓐ - Front Divider
- Ⓑ - Center Divider
- Ⓒ - Passenger Side Window Armor
- Ⓓ - Passenger Side ABS Door Panel
- Ⓔ - ABS Seat, Floor Pan & Seat Belt Extender



A SINGLE CELL, SHOWN HERE IN A PI SEDAN, PROVIDES A SECURE TRANSPORT AREA FOR EVEN LARGER PRISONERS.



## THE SINGLE CELL ADVANTAGE:

- Creates a cocoon-like cell that allows for the complete and safe enclosure of a prisoner.
- Eliminates the prisoners ability to lie down and kick out windows or damage doors.
- Maintain 100% travel & recline capabilities of the driver seat. In an crash, the seat will perform as designed by the manufacturer.



- Allows for storage behind driver seat. Keep rain gear, campaign hat, files, printer and other duty gear better stowed away.
- For The SUV's, the OEM rear seat remains in place. No testing is required as the OEM seat structure has already passed ALL required testing - no storage solution is required to house these heavy/bulky seats - AND the agency gains the benefit of an ABS seat (biohazard and contraband control).

A SINGLE CELL, SHOWN HERE IN A TAHOE, CREATES A SECURE TRANSPORT ENVIRONMENT IN ALL DIRECTIONS.

## SINGLE CELL FOR SUVs INCLUDES:

- (A) - Front Divider
- (B) - Center Divider
- (C) - Passenger Side Window Armor
- (D) - Passenger Side ABS Door Panel
- (E) - ABS Seat Cover & Seat Belt Extender
- (F) - SCA Compliant Rear Cargo Barrier (CB4)

**TSP**  
TOTAL SOLUTIONS PROVIDER!

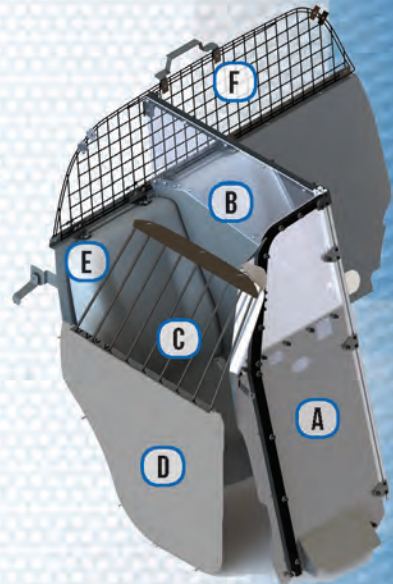

A SINGLE CELL FOR SUV, SHOWN HERE IN A PI UTILITY, TAKES ADVANTAGE OF FRONT AND SIDE DIVIDERS AND A REAR CARGO BARRIER TO CREATE A TRUE CONTAINMENT CELL FOR A PRISONER.



# WHY JOTTO DESK

# COMPUTER MOUNTS



The JOTTO DESK® Computer Mount is a No Holes drilled, ergonomic, multi-adjustable swing arm desk used as a platform for law enforcement to secure and comfortably use a laptop computer. Desktop can be exchanged out in order to secure docking stations.

## COMPUTER MOUNT INCLUDES:

- Ⓐ - Cable-Dock® Desktop
- Ⓑ - Articulated Swing Arm
- Ⓒ - Ratchet Handle
- Ⓓ - Telescoping Rod & Stand Assembly
- Ⓔ - No Holes Mounting Base



- The patented Cable-Dock® securing system uses two nylon coated stainless steel cables that wrap up and over the keyboard section of the computer for a firm and positive grip.
- The “Original” articulated swing arm enables you to pull the desktop over for comfortable operation, reducing back strain. Overall design allows you to sit and work comfortably in driver or passenger seat and store against dash while driving.
- Additionally, the Jotto Desk Laptop Mount will allow usage in a Tactically Safe position. The officer will be able to stand outside the passenger door and utilize the laptop as needed.
- Heavy gauge steel with a black powder coat finish prevents rusting and is built for long-term durability.
- Installs in minutes with no drilling required. No Holes mounting base secures to existing OEM seat bolts/structure.





# WHY JOTTO DESK

# CONTOUR CONSOLES



With the development of the Contour Console line by Jotto Desk in 2001, traditional console design was revolutionized. Rather than simply a box shoved between the seats and crammed with equipment, Jotto Desk evaluated the vehicle and designed consoles based upon what the vehicle would allow combined with the agencies needs.

## THE CONTOUR CONSOLE DIFFERENCE

- *Contour Consoles take advantage of previously unused space or voids from the vehicle manufacturer.*
- *Our consoles were designed inside the vehicle CAD data provided by the manufacturer. The end result are consoles that look as if they were an OEM piece of equipment, creating an excellent fit and finished look.*
- *Our vertical consoles were designed to improve visibility and interaction by the driver and to allow for deeper equipment to be mounted. Many Contour Consoles have been reinforced for the securing of a computer mount.*
- *Innovative designs free up valuable real estate between seats for ever expanding equipment...from arm rests to printers and barcode scanners. More importantly, our consoles free up hip room for officers.*
- *Contour Consoles were also designed with the installer in mind. Many include locations for a console side mount, arm rest, cup holders and even mic clips. Many feature knockouts for 12v outlets, speakers and even fuse panels.*

THIS CONTOUR CONSOLE FOR 11+ DODGE CHARGER INCLUDES CLIMATE CONTROL RELOCATION AND A REMOVABLE P/S WING FOR EASY ACCESS TO EQUIPMENT MOUNTED IN CONSOLE.



deeper equipment to be mounted. Many Contour Consoles have been reinforced for the securing of a computer mount.



FITS ESCAPE  
HYBRID VEHICLES



8 7 7 . 4 5 5 . 6 8 8 6

# WHY JOTTO DESK | GUN RACKS

When you need your weapon secured, yet quickly retrieved...trust Jotto Desk every time. Whether single or dual weapon, partition, rear seat or even trunk/rear hatch mounted, there is a Jotto Desk Gun Rack to meet the needs of your vehicle and the weapons you carry.

**AVAILABLE FOR:**  
**SINGLE WEAPON**  
**DUAL WEAPON**  
**PARTITION MOUNT**  
**REAR SEAT MOUNT**  
**REAR HATCH MOUNT**  
**TRUNK MOUNT**



## BLM - BARREL LOCK MOUNT

THE AR BLM GUN LOCK SECURES WEAPONS AT THE LEAST ACCESSORIZED PORTION OF THE WEAPON...THE BARREL.

Jotto Desk's Barrel Lock Mount (BLM) has set the standard for securing an AR-15. This method allows you to secure virtually any AR-15, regardless of accessories. The minimal footprint of our gun rack design assists in the mounting process and the interaction with officers...critical with today's smaller vehicle interiors. The 870 Shotgun is secured beneath the pump portion, preventing the chambering of a shell/round.



THE AR CHARGING BRACKET KEEPS A ROUND FROM BEING CHARGED WHILE SECURED IN GUN RACK.

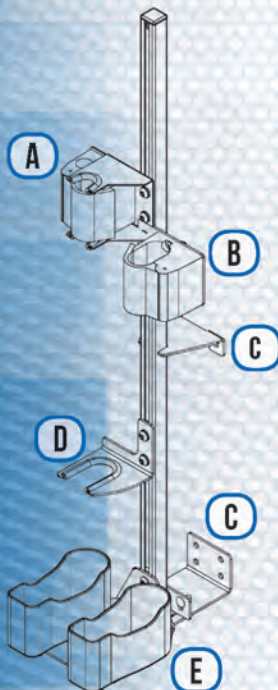

## DUAL GUN RACK INCLUDES:

- (A) - AR BLM Gun Lock
- (B) - 870 Gun Lock
- (C) - Partition Mounting Brackets
- (D) - AR Charging Bracket
- (E) - ABS Butt Plates

**TSP**  
 TOTAL SOLUTIONS PROVIDER!



870 GUN LOCK LOCATION SECURES SAFELY.



# WHY JOTTO DESK

# GREEN PLUS CERTIFIED

Assembled Products Corporation is a Green Plus Certified organization.

Green Plus is a sustainable organization that pushes Jotto Desk and the other divisions of Assembled Products Corporation to meet environmental goals in three areas: People, Performance, and Planet. They measured our efforts and results, and once we attained a certain level, they certified us as an environmentally friendly company.



**GREEN PLUS**  
PEOPLE. PLANET. PERFORMANCE.  
Institute for Sustainable Development

## OUR GREEN INITIATIVES

- *Within two years of launching the program, Assembled Products decreased electricity, water and natural gas consumption by more than 30%, 25% and 14% respectively.*
- *Jotto Desk has converted elements of our packaging into recyclable materials and partnered with vendors to do the same. We reduced our usage of virgin microfilm by 378% to greatly increased the recyclables coming in and going out.*
- *Jotto Desk offers products that are recyclable at the end of their lifespan...from our consoles, partitions, ABS seats, ABS door panels, push bumpers and trunk trays. As well, our ABS seats and floor pans are made from recycled material.*
- *APC's dedication to sustainability is evident in the work and commitment of our Environmental Sustainability Committee and by the ongoing changes and evaluation for areas of improvement.*
- *APC knows that sustainability is important to the people who buy our products and prides itself on our sustainability efforts and employee engagement programs. APC is the second Arkansas business and the 60th company in the United States to earn full Green Plus Certified Status.*



# 2011+ DODGE CHARGER



425-8103

IN THE NEXT FEW PAGES, SHOP FOR EVERYTHING YOU'LL NEED FOR THE 2011+ DODGE CHARGER'S IN YOUR FLEET. FROM BUMPER TO BUMPER, WE ARE YOUR TOTAL SOLUTIONS PROVIDER.

**TSP**  
TOTAL SOLUTIONS PROVIDER!





475-0263



475-0802



425-5640



475-0229



425-6636



475-0803



475-0420



425-6175



**475-0184**



**475-0802**



**425-5597**



**475-0051**



**475-0600**



**475-0323**



**425-5542**

## PRISONER TRANSPORT

SINGLE CELL TRANSPORT SYSTEM **475-0184**

SPACE CREATOR VEHICLE PARTITION

HIGH SECURITY/HIGH VISIBILITY **475-0802**

FULL WINDOW W/ SAFETY WIRE **475-0803**

VERTICAL WINDOW ARMOR & DOOR PANEL SET **475-0229**

SECURE GRID WINDOW ARMOR & DOOR PANEL SET **475-0420**

BIO-SEAT, FLOOR PAN & SEAT BELT EXTENDERS SET **475-0323**

## GUN RACKS

DUAL WEAPON PARTITION MOUNT GUN RACK **475-0051**

GR9-870-AR-BLM-V

DUAL WEAPON REAR SEAT MOUNT GUN RACK **475-0600**

GR6-11+DCR-870-AR-BLM

## CONSOLES & COMPUTER MOUNTS

VERTICAL CONTOUR CONSOLE **425-6175**

VERTICAL CONSOLE ACCESSORY ADAPTOR PLATE **425-6384**

CONSOLE SIDE MOUNT **425-5597**

(FOR USE WITH 425-6175)

HORIZONTAL CONTOUR CONSOLE **425-6636**

CONSOLE SIDE MOUNT **425-5542**

(FOR USE WITH 425-6636)

NO HOLES MOUNT **425-5640**

## CARGO MANAGEMENT

TRUNK TRAY **425-8103**

## BUMPER PROTECTION

PUSH BUMPER **475-0263**

# 2011+ DODGE CHARGER

**TSP**  
TOTAL SOLUTIONS PROVIDER!



# POLICE INTERCEPTOR SEDAN



425-8105

WE OFFER EVERYTHING YOU'LL  
NEED FOR THE 2013+ FORD PI  
SEDANS IN YOUR FLEET. WE  
ARE YOUR TOTAL SOLUTIONS  
PROVIDER WITH PRODUCTS  
FROM BUMPER TO BUMPER.

**TSP**  
TOTAL SOLUTIONS PROVIDER!







475-0298



475-0407



425-5019



475-0284



425-6174



475-0406



475-0315



425-6416



475-0297



475-0781



425-5599



475-0051



475-0283



475-0321



475-0780

# POLICE INTERCEPTOR SEDAN

## PRISONER TRANSPORT

SINGLE CELL TRANSPORT SYSTEM **475-0297**

SPACE CREATOR MAX VEHICLE PARTITION

HIGH SECURITY/HIGH VISIBILITY **475-0407**

FULL WINDOW W/ SAFETY WIRE **475-0406**

VERTICAL WINDOW ARMOR & DOOR PANEL SET **475-0284**

SECURE GRID WINDOW ARMOR & DOOR PANEL SET **475-0315**

BIO-SEAT, FLOOR PAN & SEAT BELT EXTENDERS SET **475-0321**

## GUN RACKS

DUAL WEAPON PARTITION MOUNT GUN RACK **475-0051**

GR9-870-AR-BLM-V

DUAL WEAPON REAR SEAT MOUNT GUN RACK **475-0283**

GR6-PI-SEDAN-870-AR-BLM

SINGLE WEAPON TRUNK MOUNT GUN RACK **475-0780**

GR4-PI-SEDAN-870-TRUNK-MOUNT

SINGLE WEAPON TRUNK MOUNT GUN RACK **475-0781**

GR4-PI-SEDAN-AR-BLM-TRUNK-MOUNT

## CONSOLES & COMPUTER MOUNTS

CONTOUR CONSOLE **425-6174**

CONSOLE SIDE MOUNT **425-5599**

(FOR USE WITH 425-6174)

AK-7 WORKSTATION CONSOLE **425-6416**

NO HOLES MOUNT **425-5019**

## CARGO MANAGEMENT

TRUNK TRAY **425-8105**

## BUMPER PROTECTION

PUSH BUMPER **475-0298**

**TSP**  
TOTAL SOLUTIONS PROVIDER!

# POLICE INTERCEPTOR UTILITY



WE OFFER A COMPLETE RANGE OF PRODUCTS FOR THE 2013+ FORD PI UTILITY VEHICLES IN YOUR FLEET. YOU CAN TRUST THAT ALL OF OUR PRODUCTS WILL WORK SEAMLESSLY TOGETHER... FIT AND FINISH.

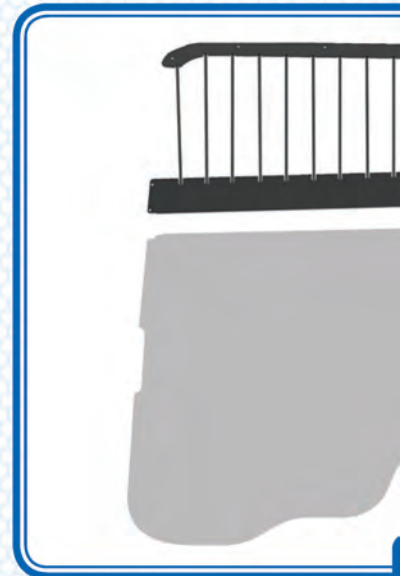



475-0772



475-0304



425-5023



475-0300



425-6193



475-0303

**TSP**  
TOTAL SOLUTIONS PROVIDER!

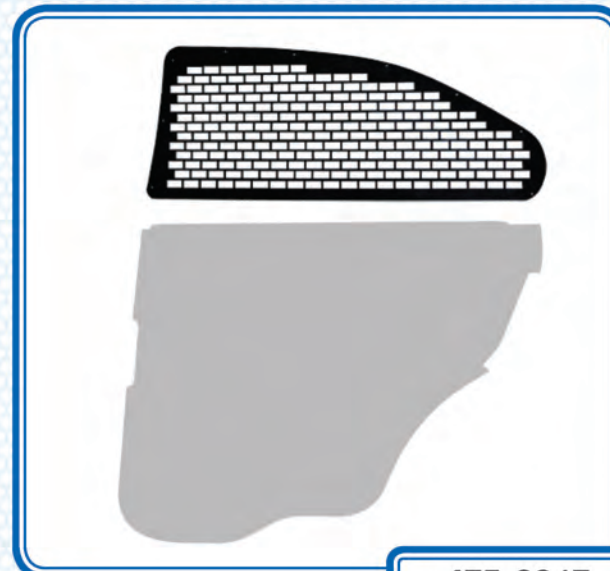

475-0317



425-6159



475-0318



425-6428



425-5598



475-0051



475-0299



475-0779



475-0778

# UTILITY POLICE INTERCEPTOR

## PRISONER TRANSPORT

SINGLE CELL TRANSPORT SYSTEM **475-0318**

SPACE CREATOR VEHICLE PARTITION

HIGH SECURITY/HIGH VISIBILITY **475-0304**

FULL WINDOW W/ SAFETY WIRE **475-0303**

CB4 CARGO BARRIER **475-0769**

VERTICAL WINDOW ARMOR & DOOR PANEL SET **475-0300**

SECURE GRID WINDOW ARMOR & DOOR PANEL SET **475-0317**

## GUN RACKS

DUAL WEAPON PARTITION MOUNT GUN RACK **475-0051**

GR9-870-AR-BLM-V

DUAL WEAPON REAR SEAT MOUNT GUN RACK **475-0299**

GR6-PI-UTILITY-870-AR-BLM

SINGLE WEAPON REAR HATCH MOUNT GUN RACK **475-0778**

GR4-PI-UTILITY-870-TRUNK-MOUNT

SINGLE WEAPON REAR HATCH MOUNT GUN RACK **475-0779**

GR4-PI-UTILITY-AR-BLM-TRUNK-MOUNT

## CONSOLES & COMPUTER MOUNTS

CONTOUR CONSOLE **425-6193**

CONSOLE SIDE MOUNT **425-5598**

(FOR USE WITH 425-6193)

AK-7 WORKSTATION CONSOLE **425-6428**

AK-12 WORKSTATION CONSOLE **425-6159**

NO HOLES MOUNT **425-5023**



## BUMPER PROTECTION

JOTTO FORCE PUSH BUMPER **475-0750**

JOTTO FORCE PUSH BUMPER WITH WRAP **475-0772**



# 2011+ CHEVY TAHOE



475-0754

WITH THESE PRODUCTS FOR THE  
2011+ CHEVY TAHOE VEHICLES  
IN YOUR FLEET, YOUR PUBLIC  
SAFETY EQUIPMENT WILL BE  
SAFELY ORGANIZED & SECURED.

**TSP**  
TOTAL SOLUTIONS PROVIDER!







475-0757



475-0763



425-5117



475-0064



410-9801



475-0764



425-6266



475-0426



**475-0755**



**425-6112**



**475-0761**



**475-0051**



**475-0534**



**425-6417**



**475-0762**

## PRISONER TRANSPORT

SINGLE CELL TRANSPORT SYSTEM **475-0755**

### SPACE CREATOR VEHICLE PARTITION

HIGH SECURITY/HIGH VISIBILITY **475-0763**

FULL WINDOW W/ SAFETY WIRE **475-0764**

### FLAT PANEL VEHICLE PARTITION

HIGH SECURITY/HIGH VISIBILITY **475-0761**

FULL WINDOW W/ SAFETY WIRE **475-0762**

CB4 CARGO BARRIER **475-0754**

VERTICAL WINDOW ARMOR & DOOR PANEL SET **475-0064**

SECURE GRID WINDOW ARMOR & DOOR PANEL SET **475-0426**

## GUN RACKS

DUAL WEAPON PARTITION MOUNT GUN RACK **475-0051**

GR9-870-AR-BLM-V

DUAL WEAPON REAR SEAT MOUNT GUN RACK **475-0534**

GR6-TAHOE-870-AR-BLM

## CONSOLES & COMPUTER MOUNTS

CONTOUR CONSOLE WITH LOCKING LID **425-6417**

CONTOUR CONSOLE WITH SIDE STORAGE **425-6418**

AK-16 WORKSTATION CONSOLE **425-6266**

CONTOUR CONSOLE INSERT **425-6112**

NO HOLES MOUNT **425-5117**

## CARGO MANAGEMENT

JOTTO-CARGO SLIDE **410-9801**

## BUMPER PROTECTION

JOTTO FORCE PUSH BUMPER **475-0757**

JOTTO FORCE PUSH BUMPER WITH WRAPS **475-0770**

2011+ CHEVY  
TAHOE

**TSP**  
TOTAL SOLUTIONS PROVIDER!



# 2011+ CHEVY CAPRICE



IN THE NEXT FEW PAGES, SHOP EVERYTHING YOU'LL NEED FOR 2011+ CHEVY CAPRICE VEHICLES IN YOUR FLEET. FROM BUMPER TO BUMPER, WE ARE YOUR TOTAL SOLUTIONS PROVIDER.

**TSP**  
TOTAL SOLUTIONS PROVIDER!

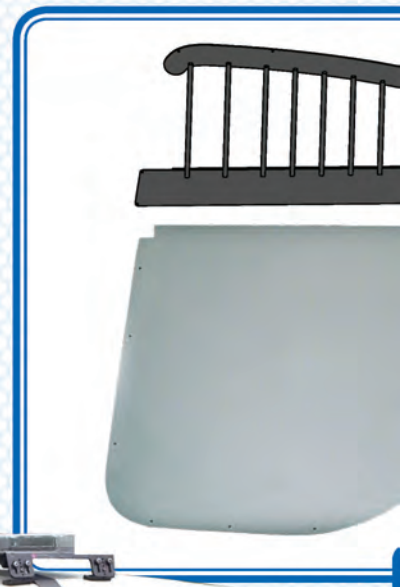



475-0264



475-0809



425-5591

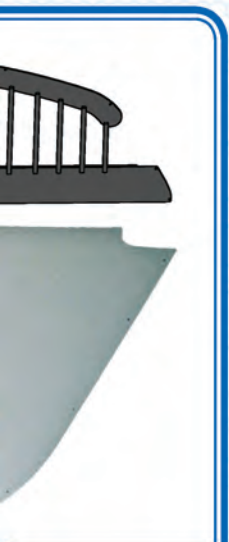

475-0256



425-6693



475-0811



475-0394



425-6691



475-0815



475-0808



475-0810



475-0737



475-0733



475-0327



475-0624

## PRISONER TRANSPORT

SINGLE CELL TRANSPORT SYSTEM **475-0815**

### SPACE CREATOR VEHICLE PARTITION

HIGH SECURITY/HIGH VISIBILITY **475-0809**

FULL WINDOW W/ SAFETY WIRE **475-0808**

### FLAT PANEL VEHICLE PARTITION

HIGH SECURITY/HIGH VISIBILITY **475-0811**

FULL WINDOW W/ SAFETY WIRE **475-0810**



VERTICAL WINDOW ARMOR & DOOR PANEL SET **475-0256**

SECURE GRID WINDOW ARMOR & DOOR PANEL SET **475-0394**

BIO-SEAT, FLOOR PAN & SEAT BELT EXTENDERS SET **475-0327**

## GUN RACKS

### FLAT PARTITION ONLY

SINGLE WEAPON: REMINGTON 870: GR5-870-V-CAPRICE **475-0737**

SINGLE WEAPON: AR15: GR5-AR-BLM-V-CAPRICE **475-0736**

DUAL WEAPON: REMINGTON 870 & AR15: GR5-870-AR-BLM-V-CAPRICE **475-0735**

### SPACE CREATOR PARTITION ONLY

SINGLE WEAPON: REMINGTON 870: GR9-870-V-CAPRICE-SC **475-0734**

SINGLE WEAPON: AR15: GR9-AR-BLM-V-CAPRICE-SC **475-0733**

DUAL WEAPON: REMINGTON 870 & AR15: GR9-870-AR-BLM-V-CAPRICE-SC **475-0732**

### REAR SEAT MOUNT

DUAL WEAPON: REMINGTON 870 & AR15: GR6-870-AR-BLM-V-CAPRICE **475-0624**

## CONSOLES & COMPUTER MOUNTS

CONTOUR CONSOLE (FOR 9C1 ONLY) **425-6691**

9C1 MDC WORKSTATION CONSOLE **425-6693**

NO HOLES MOUNT **425-5591**

## CARGO MANAGEMENT

TRUNK TRAY **425-8104**

## BUMPER PROTECTION

PUSH BUMPER **475-0264**



2011+ CHEVY  
CAPRICE

# 2008+ CHEVY IMPALA



425-8102



EVERYTHING YOU'LL NEED FOR  
2008+ CHEVY IMPALA VEHICLES  
IN YOUR FLEET CAN BE FOUND  
ON THE NEXT FEW PAGES. BY  
PROVIDING PRODUCTS FROM  
BUMPER TO BUMPER, KNOW  
THAT WE ARE YOUR TOTAL  
SOLUTIONS PROVIDER.



**TSP**  
TOTAL SOLUTIONS PROVIDER!







475-0185



475-0727



425-5337



425-5453



425-6137



475-0804



475-0728



425-6136



**475-0325**

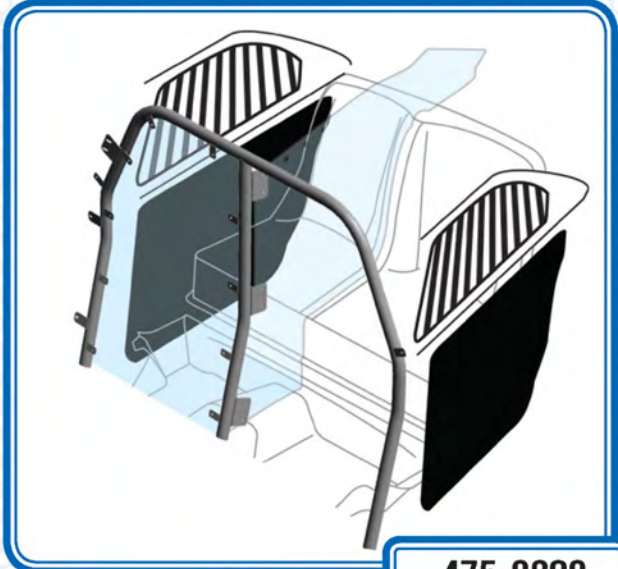

**475-0280**



**425-6136**



**475-0051**



**475-0537**



## PRISONER TRANSPORT

### SPACE CREATOR VEHICLE PARTITION

- HALF SLIDER - ALL POLY **475-0727**
- HALF SLIDER - POLY/SAFETY WIRE **475-0728**
- CENTER SLIDER - ALL POLY **475-0729**
- CENTER SLIDER - POLY/SAFETY WIRE **475-0730**

### STANDARD VEHICLE PARTITION

- HALF SLIDER - ALL POLY **475-0804**
- HALF SLIDER - POLY/SAFETY WIRE **475-0805**
- CENTER SLIDER - ALL POLY **475-0806**
- CENTER SLIDER - POLY/SAFETY WIRE **475-0807**



PTS 9000 **475-0280**

VERTICAL WINDOW ARMOR & DOOR PANEL SET **475-0185**

BIO-SEAT, FLOOR PAN & SEAT BELT EXTENDERS SET **475-0325**

## GUN RACKS

DUAL WEAPON PARTITION MOUNT GUN RACK **475-0051**  
GR9-870-AR-BLM-V

DUAL WEAPON REAR SEAT MOUNT GUN RACK **475-0537**  
GR6-IMPALA-870-AR-BLM

## CONSOLES & COMPUTER MOUNTS

CONTOUR CONSOLE 9" (9C1 OR 9C3) **425-6136**

CONTOUR CONSOLE 12" (9C1 ONLY) **425-6137**

NO HOLES MOUNT **425-5337**

RETRO FIT COMPUTER MOUNT **425-5453**

## CARGO MANAGEMENT

TRUNK TRAY **425-8102**



# 2008+ CHEVY IMPALA



**475-0516**



**425-5585**



**425-5586**



**425-6271**



**425-6385**



**425-5603**

# ADDITIONAL VEHICLES

## PRISONER TRANSPORT

### 10+ FORD F150 STANDARD VEHICLE PARTITION

HALF SLIDER - ALL POLY **475-0516**

HALF SLIDER - POLY/SAFETY WIRE **475-0517**

CENTER SLIDER - ALL POLY **475-0518**

CENTER SLIDER - POLY/SAFETY WIRE **475-0519**

### 11+ FORD F250-550 STANDARD VEHICLE PARTITION

HALF SLIDER - ALL POLY **475-0496**

HALF SLIDER - POLY/SAFETY WIRE **475-0497**

CENTER SLIDER - ALL POLY **475-0498**

CENTER SLIDER - POLY/SAFETY WIRE **475-0499**

## CONSOLES & COMPUTER MOUNTS

12+ FORD F250-550 CONTOUR CONSOLE **425-6271**

11+ EXPLORER CONTOUR CONSOLE **425-6385**

12+ EXPLORER NO HOLES MOUNT **425-5603**

10+ FORD F150 NO HOLES MOUNT **425-5585**

11+ FORD F250-550 NO HOLES MOUNT **425-5586**



**TSP**  
TOTAL SOLUTIONS PROVIDER!





# STANDARD CONSOLES

## STANDARD CONSOLES

SMALL CONSOLE 9" **425-6010**

MEDIUM CONSOLE 12" **425-6011**

LARGE CONSOLE 15" **425-6012**

LAZY "L" CONSOLE 18" **425-6232**

## WORKSTATION CONSOLES

AK-12 CONSOLE **425-6159**

AK-16 CONSOLE **425-6266**

## MODULAR CONSOLES

FIRE/EMS PACKAGE 1 **425-6248**

FIRE/EMS PACKAGE 2 **425-6249**



**425-6248**



**425-6249**

# FLOORPLATES

SEE STANDARD CONSOLES - SEE PAGE 38-39.



425-6133



425-6142

## FORD

PI SEDAN ('13+) 425-6614

PI UTILITY ('13+) 425-6615

F150 ('09+) 425-6142

F250+ ('08+) 425-6133

EXPEDITION ('03+) 425-6206

## CHEVY

TAHOE/SUBURBAN ('00+) 425-6204

SILVERADO ('00+) 425-6204

## DODGE

RAM ('09+) 425-6191

## UNIVERSAL

UNIVERSAL/DRILL DOWN 425-6203

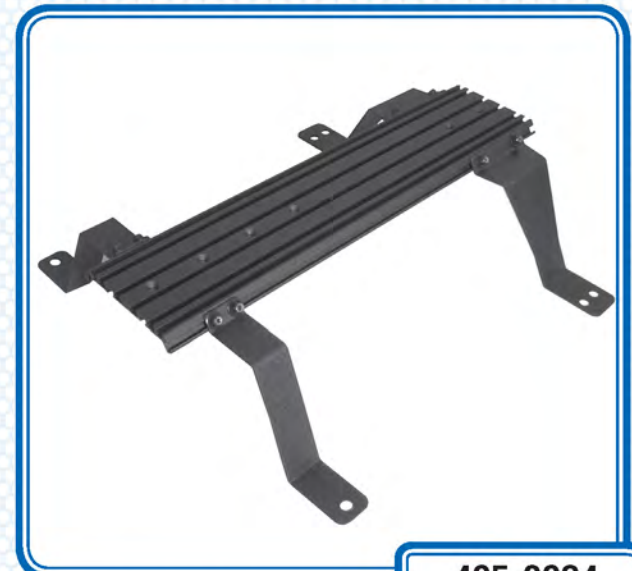

425-6204

TOP DOWN INSTALLATION - BOLTS SLIDE ALONG EXTRUSION TO ALLOW PROPER POSITION OF CONSOLE AND ACCESSORIES

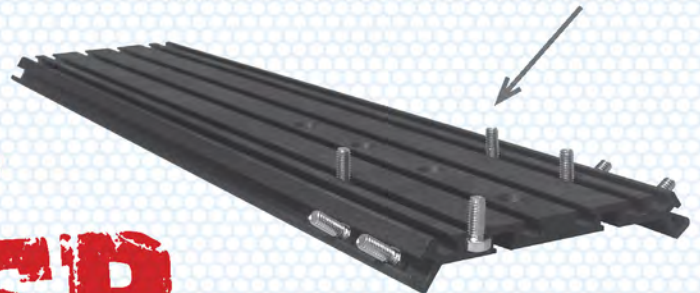





**LIVE WORK OR PLAY! LIFE AT YOUR FINGERTIPS!**

**SLIDE EQUIPMENT  
OUT TO YOU INSTEAD  
OF CLIMBING IN OR  
OVER CARGO.**



**GM / CHEVY**

	WEIGHT RATING	DIMEN.	MODEL NUMBER
'02+ AVALANCHE	800LB	63" X 49"	410-9057
'04+ CREW CAB 5.75'	800LB	65" X 49"	410-9040
'99+ SWB 6.5'	800LB	76" X 49"	410-9046
'07+ TAHOE *SUV	800LB	44" X 46"	410-9801
'07+ SUBURBAN *SUV	800LB	63" X 46"	410-9800
'99+ SWB 6.5'	1200LB	76" X 49"	410-9055
'99+ LWB 8'	1200LB	95" X 49"	410-9037
'99+ LWB 8'	2000LB	95" X 49"	410-9071

**PROVIDE EASY ACCESS TO CARGO IN A PICKUP TRUCK OR SUV. GET STEEL STRENGTH WITH THE LIGHTWEIGHT BEAUTY OF ANODIZED ALUMINUM. CONSTRUCTED WITH AIRCRAFT GRADE ALUMINUM, OUR PATENT PENDING ALUMATRACK SYSTEM PROVIDES STRENGTH AND PRECISE PERFORMANCE.**

**DODGE**

	WEIGHT RATING	DIMEN.	MODEL NUMBER
'02+ FULL SIZE 6.3'	800LB	74" X 49"	410-9038
'99+ FULL SIZE 8'	1200LB	95" X 49"	410-9037
'99+ FULL SIZE 8'	2000LB	95" X 49"	410-9071

**FORD**

	WEIGHT RATING	DIMEN.	MODEL NUMBER
'99+ FULL SIZE 5.5'	800LB	65" X 49"	410-9040
'99+ FULL SIZE 6.5'	800LB	76" X 49"	410-9046
'99+ FULL SIZE 6.5'	1200LB	76" X 49"	410-9055
'99+ F250/350 6.75'	1200LB	80" X 49"	410-9067
'99+ F250/350 6.75'	2000LB	80" X 49"	410-9076
'99+ FULL SIZE 8'	1200LB	95" X 49"	410-9037
'99+ FULL SIZE 8'	2000LB	95" X 49"	410-9071



**JOTTO-CARGO  
SLIDE**

**FLOORING REQUIRED: Order Aluma Plank Flooring or Use Your Own Plywood Flooring. Aluma Plank Flooring included with SUV/Slides.**

**8 7 7 . 4 5 5 . 6 8 8 6**



475-0050



475-0051

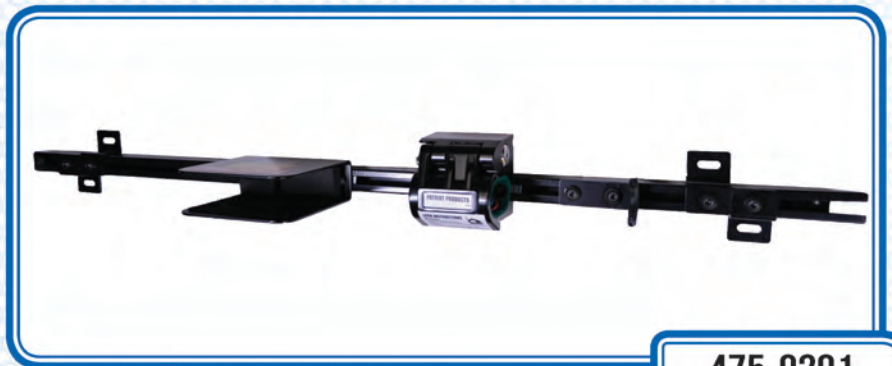

475-0201

# BLM BARREL LOCK MOUNT



475-0538



475-0023

ALL MOUNTS DESIGNED FOR AR 15 AND/OR REMINGTON 870/MOSSBERG 500.  
IF OTHER TYPE OF WEAPON, CONTACT YOUR SALES MANAGER.

## VERTICAL - PARTITION MOUNTED

### WORKS WITH FLAT PARTITION ONLY

SINGLE WEAPON PARTITION MOUNT GUN RACK **475-0050**  
GR1-870-V

SINGLE WEAPON PARTITION MOUNT GUN RACK **475-0104**  
GR2-AR-BLM-V

### WORKS WITH FLAT OR RECESSED PARTITION

SINGLE WEAPON PARTITION MOUNT GUN RACK **475-0192**  
GR9-870-V

SINGLE WEAPON PARTITION MOUNT GUN RACK **475-0191**  
GR9-AR-BLM-V

DUAL WEAPON PARTITION MOUNT GUN RACK **475-0051**  
GR9-870-AR-BLM-V

## VERTICAL - REAR SEAT MOUNTED - SUV

DUAL WEAPON REAR SEAT MOUNT GUN RACK **475-0538**  
GR6-870-AR-BLM-SUV

## UNIVERSAL - TRUNK MOUNTED

SINGLE WEAPON TRUNK MOUNT GUN RACK **475-0201**  
GR4-870-UTM

SINGLE WEAPON TRUNK MOUNT GUN RACK **475-0023**  
GR4-AR-BLM-UTM



ADDITIONAL GUN RACKS AVAILABLE. SEE SPECIFIC VEHICLE GUN RACK PAGES FOR MORE INFORMATION OR CALL FOR DETAILS.

8 7 7 . 4 5 5 . 6 8 8 6

# GUN RACKS

# DOCKING STATION CF31 AND B300



***This intelligent docking station is perfect for mixed fleets since it is compatible with CF-31/30/29/28 and also the Getac B300.***

Jotto Desk has done it again with the Kodiak Mobile Docking Station. We have taken it to the next level by making some key internal changes to our CF31 docking station – which have allowed Jotto Desk to release it as a fully compatible docking station for the Panasonic CF31 AND the Getac B300.

The CF31 docking station was first introduced in January 2011 – and is the only docking station on the market that is fully compatible with the CF31, CF30, CF29 and CF28...and now you can add the Getac B300 to the list. Additionally, this docking station includes the 120 watt Power Supply and Power Management Circuitry as Standard Features...at no additional cost.

## **STANDARD FEATURES (INCLUDED AT NO EXTRA COST)**

- (5) USB 2.0 PORTS
- 120 WATT POWER SUPPLY
- (1) ETHERNET PORT
- SURGE SUPPRESSION
- REVERSE VOLTAGE PROTECTION
- LOW VOLT MONITORING
- AUTO ACTIVATION & SHUTDOWN
- TRANSIENT VOLTAGE PROTECTION
- USER CONTROLLED TIMED SHUTDOWN
- SLAM LOCK - THEFT PREVENTION



**NO POWER  
SUPPLY NEEDED**



**NO CHARGE  
GUARD NEEDED**



**MIL-STD-810F**  
 VIBRATION TESTING: MIL-STD 810F  
 514.5 COMPOSITE WHEELED VEHICLE

**KDCF31/B300 iDOCK  
 DOCKING STATION**

**450-4101**

STANDARD DOCKING STATION

**450-4102 (PANASONIC ONLY)**

W/ SINGLE WIRELESS PASSTHROUGH

**450-4103**

W/ DUAL WIRELESS PASSTHROUGH



KODIAK MOBILE BY JOTTO DESK IS AN ISO 9001:2008 CERTIFIED COMPANY

8 7 7 . 4 5 5 . 6 8 8 6

# DOCKING STATIONS CF53



The CF53 docking station is based on the similar design as our ever popular CF31 docking station. This design has been serving the law enforcement industry since 1996 and has been proven a tough, rugged design. The new CF53 iDock includes a new robust docking interface that is designed for the locking mechanism that gives the user the option to leave the docking station unlocked for rapid undocking.



The new KDCF-53 iDock's "auto dock" feature automatically latches the docking station so you no longer have to use the key to lock the computer into the dock. The key is just a preventive step to keep it locked from theft. The new CF-53 iDock has the smallest footprint in the industry, smaller than the laptop itself – making it very easy to mount in the vehicle.

This unit is constructed of welded steel and features our internal port replicator and internal "intelligent" power management circuitry. All functions can be controlled and monitored at the tactile membrane control panel located at the front of the docking station. Surge suppression, avalanche voltage protection, reverse voltage protection, emi filtering, transient voltage protection, low voltage monitoring, auto activation and shutdown, user controlled timed shutdown are standard. This docking station is built to MIL-STD 810F standards.

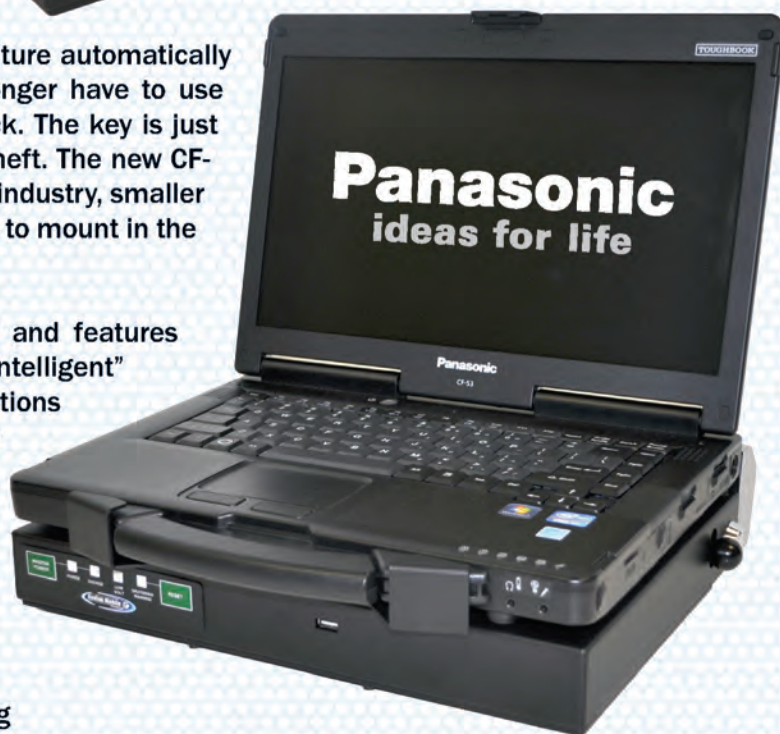

#### **STANDARD FEATURES INCLUDED (AT NO EXTRA COST)**

- (6) USB 2.0 PORTS (5 REAR, 1 FRONT)
- 120 WATT POWER SUPPLY
- (1) ETHERNET PORT
- LOW VOLT MONITORING
- AUTO SHUTDOWN TIMER
- SURGE SUPPRESSION
- AVALANCHE VOLTAGE PROTECTION
- 4 LED INDICATORS (FOR FIELD TROUBLESHOOTING)

#### **KDCF53 iDOCK DOCKING STATION**

**450-4111**



KODIAK MOBILE BY JOTTO DESK IS AN  
ISO 9001:2008 CERTIFIED COMPANY

# THANK YOU FOR THE OPPORTUNITY

Jotto Desk looks forward to earning the opportunity to become your Total Solutions Provider. We have worked hard to establish ourselves as the premier TSP in the public safety market. You can have confidence that you can place One Order from Jotto Desk and Know that the solutions will ship quickly, Know they will ship correctly, Know they will be competitively priced, Know they will be of the highest quality and Know they will work together seamlessly. TRUST Jotto Desk to be your Total Solutions Provider for whichever vehicle your agency chooses.



**TSP**  
TOTAL SOLUTIONS PROVIDER!

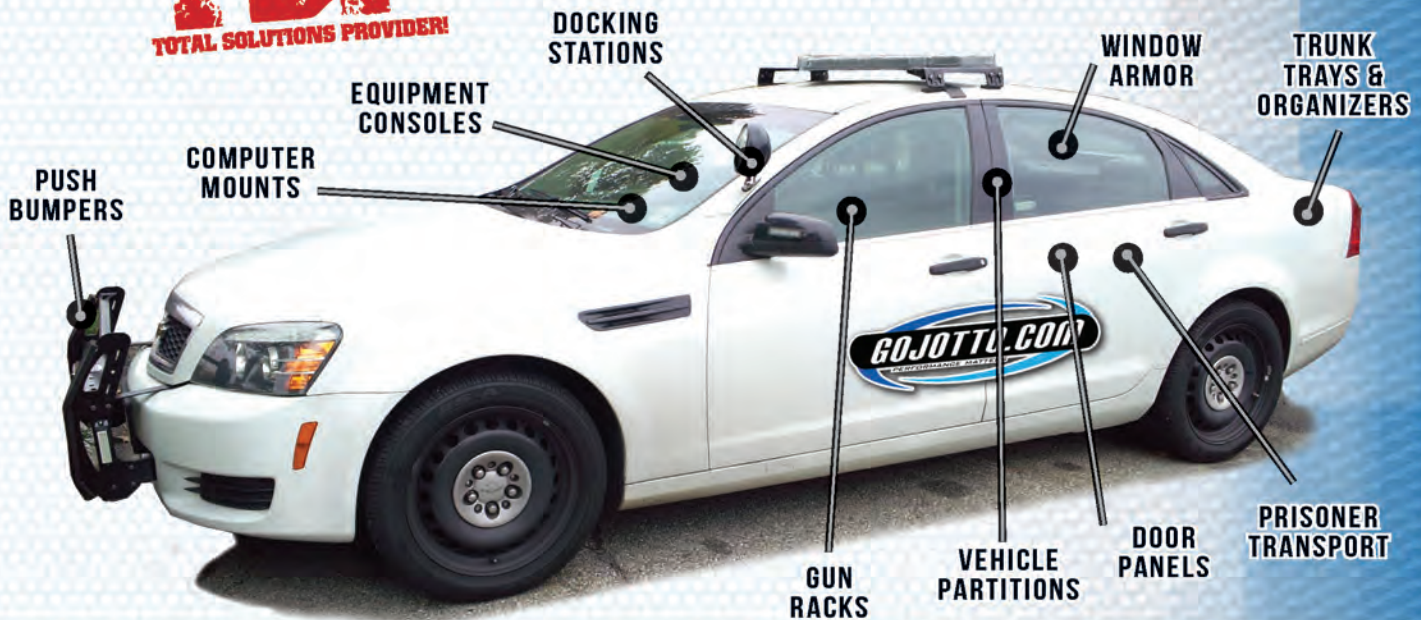

James Elmore ext. 6493  
National Sales Manager  
- Public Safety -  
JELMORE@JOTTODESK.COM



CUSTOMER SERVICE

Johnny Knipe ext. 6406  
Public Safety Sales Manager  
- East Region -  
JKNIPE@JOTTODESK.COM



PHONE: 877.455.6886

Wayne Weiser ext. 6458  
Public Safety Sales Manager  
- West Region -  
WWEISER@JOTTODESK.COM

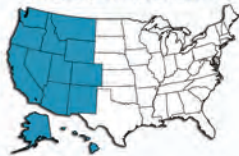

FAX: 479.936.8620

Rodney Weyer ext. 6490  
Public Safety Sales Manager  
- South Region -  
RWWEYER@JOTTODESK.COM



EMAIL: CUSTOMERSVC@JOTTODESK.COM

Kimberly Burt ext. 6474  
Public Safety Sales Manager  
- Central Region -  
KYMBERLY@JOTTODESK.COM



877.455.6886



8 7 7 . 4 5 5 . 6 8 8 6

2 0 9 W . E a s y S t r e e t , R o g e r s A R 7 2 7 5 6

Copyright © 2013 Jotto Desk. Cable-Dock® are patented products and registered trademarks of Assembled Products™ Corporation. Contour Console™ has design and utility patents. JOTTO-CARGO SLIDE™ is a trademark and patent pending product of Assembled Products™ Corporation. Additional patents pending. Specifications subject to change without notice. Printed in the USA.