



**NightSearcher**  
from Will-Burt

**RECHARGEABLE  
LIGHTING PRODUCTS**

[WWW.WILLBURT.COM/NIGHTSEARCHER](http://WWW.WILLBURT.COM/NIGHTSEARCHER)

The Will-Burt Company is the proud exclusive distributor of NightSearcher rechargeable lighting products. NightSearcher was established in 1989 and has provided the world with portable rechargeable lighting solutions that are reliable, durable, and easy to use. Applications of NightSearcher products range through multiple markets including fire, law enforcement, towing, security, construction, mining, and more. All products are powered by no maintenance lithium-ion batteries providing longevity and reliability in temperatures from -4° to 140°F, as well as containing a battery management system to protect against overcharging. While NightSearcher is located in the United Kingdom, Will-Burt will hold stock of core products within the United States.

The Will-Burt Company, headquartered in Orrville, Ohio, is the world's premier manufacturer of mobile telescoping masts, towers and pan and tilt positioners. We offer virtually every mobile payload elevation and integration solution for defense, government, first responders, cellular and mobile, broadcast, energy production and other markets. Will-Burt also offers contract manufacturing, metal fabrication, powder-coating, and rapid prototyping services. Will-Burt is an international company with offices and manufacturing in the USA, England, and Germany along with offices in Singapore and a joint venture in Turkey. All Will-Burt Company manufacturing locations are backed by a certified ISO 9001:2015 Quality Management System. Incorporated in 1918, Will-Burt is 100% employee-owned and is classified as a small business.

NightSearcher professional products are carefully designed and manufactured to the highest standards to ensure the reliability and durability our customers need. This is why we offer a 3-year standard warranty on all manufacturing defects and 1-year warranty on all rechargeable batteries from the date of purchase.



**CONTENTS**



**TOWER PRO 5K** ..... 4-5



**EXPLORER XPL** ..... 15



**SOLARIS PRO 16K** ..... 6-7



**LIGHTWAVE 520** ..... 16



**SOLARIS DUO 40K** ..... 8-9



**WORKSTAR CONNECT** ..... 17-18



**MEGASTAR 20K** ..... 10-11



**KANGASTAR 10K** ..... 19-21



**GALAXY PRO 6K** ..... 12-13



**RECHARGEABLE LED WARNING LIGHTS** ..... 22-23



**PANTHER XHP-X** ..... 14





## TOWER PRO 5K

Portable, collapsible, and rechargeable AC floodlight

### ESSENTIAL FEATURES

- Quick and easy setup
- Multi-angle rotational light
- Can be Powered Directly from AC Charger
- 2.2 ft / 0.66m when folded
- Tripod extends to 4.9 ft / 1.5m
- Robust housing
- Switch & brightness control panel
- Warm white and cool white light modes
- Battery charging indicator



### Supplied with:

AC charger | Carry Bag | Ground Spikes



### SPECIFICATIONS

	Tower Pro 5K
	5,000
	Up to 295 ft. / 90m
	1-5 hours
<b>MODE</b>	High / Medium / Low
	7.4V 4000mAh, 29.6Wh
	6 hours
	IPX4
	4.8 x 6.3 x 35 in. / 122 x 160 x 890mm
	9.9 lb / 4.5 kg
<b>CODE</b>	5837201



Carry bag for quick and easy transport



Built-in cable and charger wrapping system for tidy storage

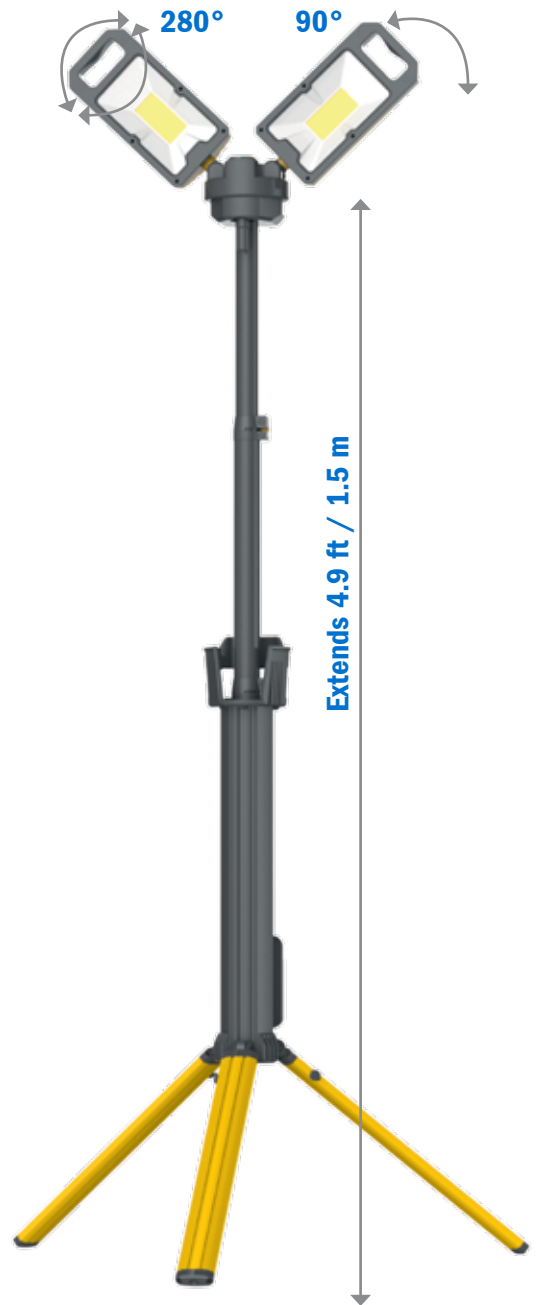

Extends 4.9 ft / 1.5 m



Cool white beam



Warm white beam

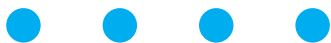

Battery charging and status indicators with 6 hour charging time



Reversible ground spikes



## SOLARIS PRO 16K

The programmable LED floodlight with a 48 hours runtime!

### ESSENTIAL FEATURES

- High powered LEDs
- Lightweight and portable
- Fast deployment
- Extends to 6 ft. / 1.85m with built in cable to avoid trip hazards
- Built in stability legs for use on uneven ground
- 180° Swivel and tilting light head
- Lightweight Lithium-Ion batteries
- Dual optics - Spot and wide beam
- Emergency light mode

### Supplied with:









AC charger and shoulder strap

### Optional Accessories:

Vehicle charger: 5837501

Ground pegs: 5837601

### SPECIFICATIONS

	Solaris Pro 16K
	16,000
	Up to 1640 ft. / 500m
	2.25-48 hours
<b>MODE</b>	Boost (Search + Flood) / Search / Flood
	14.8V 18.2Ah, 269.36Wh
	6 hours
	IP65
	20.4 x 6.1 x 8.7 in. 517 x 155 x 220mm
	15.4 lb / 7 kg
<b>CODE</b>	5837801

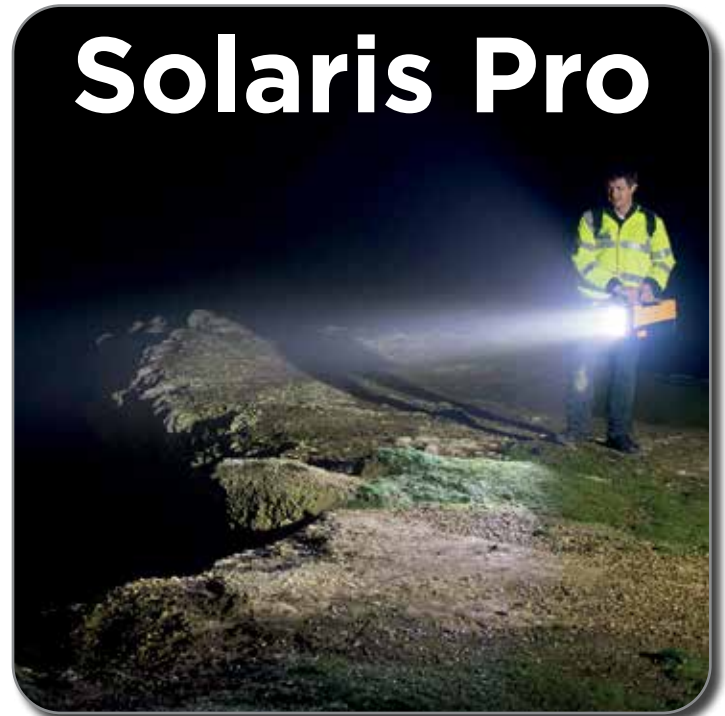

Lightweight for easy transportation



Compact size for storage





**LCD programmable display**

For selection of operation modes and programming a runtime of up to for 48 hours



**Light mode & runtime digital selector**



**Battery status by color**

**2 Battery options available**

Dual Optics  
Spot and Wide Beam

Flood

Spot



## SOLARIS DUO 40K

**Most powerful portable area light in the world**

### ESSENTIAL FEATURES

- High powered LEDs
- Portable and fast deployment
- 2 telescopic masts reaching up to 6.2 ft / 1.9m
- Swivel and tilting heads
- Built in stability legs for use on uneven ground
- Sturdy moulded insert to store parts inside
- Housed in highly robust IP67 polycarbonate case
- Battery status indicator
- Sturdy and stackable







#### Supplied with:

AC charger

#### Optional Accessories:

Vehicle charger: 5837501

### SPECIFICATIONS

	Solaris Duo 40K
	40,000 - 2 x 20,000 heads
	Up to 328 ft. / 100m
	3-24 hours
<b>MODE</b>	High / Medium / Low / Eco
	50Ah, 754.80Wh
	7 hours 20 min
	11 x 15 x 22.4 in. / 280 x 380 x 570mm
	43.4 lb. / 19.7 kg
<b>CODE</b>	5837701



#### Battery Status Indicator

High: Green | Medium: Amber | Low: Red



#### Quick lock release



Best replacement for generator powered lights



Everything stores inside  
IP67 Case

Extendable  
handle and  
wheels



## MEGA STAR 20K

**Rechargeable floodlight  
for remote locations**

### ESSENTIAL FEATURES

- IP65 waterproof polyethylene case
- 1 minute setup
- Full kits fits in waterproof bag
- Illuminating remote areas where lighting is crucial
- Durable all-weather construction
- Light and easy to carry with shoulder strap
- Additional power packs are available for longer runtimes
- Extends to 8.2 ft / 2.5 m

### Supplied with:

Light Head | Tripod | Battery Pack  
Weatherproof Bag | AC Charger

### Optional Accessories:

Additional power packs for longer run times: 5837401  
Vehicle Charger: 5837501 | Ground pegs: 5837601

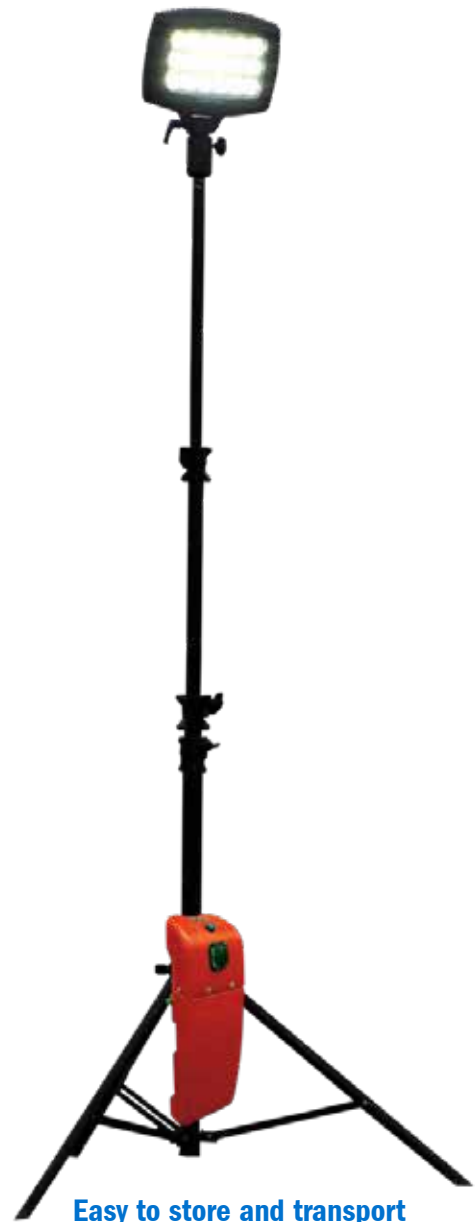

### SPECIFICATIONS

	MegaStar 20K
	20,000
	Up to 164 ft. / 50m
	2-8 hours
<b>MODE</b>	High / Medium / Low / Eco
	14.8V 18Ah, 266.40Wh
	7 hours 20 min
	IP65
	3 x 1.2 x 0.6 in. / 75 x 30 x 15mm
	9.9 lb. / 9.5 kg
<b>CODE</b>	5837301

Entire kit is supplied in a waterproof bag



Upgraded battery pack



Stability Ground Pegs



Hook-on tripod bracket



Extends 11.5 ft. / 3.5 m

Red / Amber / Green



Light modes operated from battery pack



## GALAXY PRO-6K

**6000 Lumens rechargeable floodlight, ideal for all environments**

### ESSENTIAL FEATURES

- Improved electronics for enhanced performance
- Rechargeable or powered directly from AC charger
- Drop tested from 8 ft. / 2.5m
- Designed for use in harsh, industrial locations
- Robust housing made from the toughest composite materials
- Charger storage compartment
- Lightweight - only 3.3 lb / 1.5kg
- IK07 Impact Protection

### Supplied with:

AC charger

### Optional Accessories:









2m Tripod: 5837101 | 3.5m Tripod: 5837001

T-Bar Bracket: 5836801 | Vehicle Charger: 5836901

Set of 3 Magnetic Mounts: 5836601

Single Magnet Mount: 5836701

### SPECIFICATIONS

	Galaxy Pro 6K
	6,000
	Up to 196 ft. / 60m
	2.5-60 hours
<b>MODE</b>	High / Medium / Low / Dimmable
	7.4V 13.2Ah, 97.68Wh
	8 hours
	IP54
	12.2 x 13.8 x 11.2 in. / 310 x 350 x 285mm
	3.3 lb. / 1.5 kg
<b>CODE</b>	5836501



**Optional T-Bar tripod - gives 12,000 lumens**



**Toughest composite materials**



Battery status indication



120° Adjustable tilting head

Folds flat to carry or easy storage



Hi-Vis reflective feet



196 ft. / 60 m beam



Water resistant IP54



## PANTHER XHP-X

The searchlight chosen by professionals

### ESSENTIAL FEATURES

- 1,800 lumens with long distance 3,280 ft / 1000m beam
- Lightweight design
- Rechargeable lithium battery
- Robust polyethylene construction
- Virtually unbreakable casing
- Unique deep dish reflector
- Adjustable stand
- Battery charging indicator
- Parabolic reflector enables maximum distance to lumen ratio

### Supplied with:

AC charger | Adjustable Stand | Shoulder Strap

### Optional Accessories:

Vehicle/wall mounting bracket: 5838001

Vehicle Charger: 5836901



### SPECIFICATIONS

	Panther XHP-X
	1,800
	Up to 3,280 ft. / 1000m
	3-8 hours
<b>MODE</b>	High / Low
	7.4V 4.4Ah, 32.56Wh
	9 hours
	IP54
	10.2 x 5.9 x 7.1 in. / 260 x 150 x 180mm
	2.2 lb. / 1 kg
<b>CODE</b>	5837901





## EXPLORER XPL

Wall or vehicle mounted rechargeable flashlight designed for professionals

### ESSENTIAL FEATURES

- 1,100 Lumens with 1968 ft / 600m beam
- Rechargeable lithium battery
- Type III hard anodised aluminum housing
- Powerful long spot beam
- Tail end button - designed for tactical use
- Battery charging indicator
- Textured body for secure grip
- IK07 shock proof
- Aircraft grade aluminium
- Ideal for domestic, security, and emergency use

### Supplied with:

Li-ion Battery | Charging Station | Red Cone

### Optional Accessories:

Vehicle Charger: 5838201



Supplied with red Cone for signalling

### SPECIFICATIONS

	Explorer XPL
	1,100
	Up to 1968 ft. / 600m
	1-12 hours
<b>MODE</b>	High / Low / Flashing / SOS
	3.7V 2200Ah, 8.14Wh
	6 hours
	IP65
	4.7 x 7.5 x 2.75 in. / 120 x 190 x 70mm
	0.62 lb. / 280 g
<b>CODE</b>	5828101



6 white LEDs will illuminate automatically in the event of a power cut

Supplied with a charging station - convenient and always ready fully charged

## LIGHT WAVE 520

Rechargeable, Spot & Flood beam with ON/OFF wave sensor

### ESSENTIAL FEATURES

- 520 lumen with 460 ft / 140m beam
- Dimmable on all light modes
- Spot to flood beam
- Battery status indicator
- Lightweight - only 96g
- Helmet mountable with clips
- Adjustable non-slip head straps









#### Supplied with:

USB-C charging cable

#### Optional Accessories:

Vehicle Charger: 5838201

### SPECIFICATIONS

	Light Wave 520
	520
	Up to 460 ft. / 140m
	2.5-5 hours
<b>MODE</b>	Spot + Flood / Flood / Spot
	3.7V 1800Ah, 6.66Wh
	3 hours
	IP44
	2.6 x 1.6 x 1.9 in. / 65 x 40 x 47mm
	0.2 lb. / 96 g
<b>CODE</b>	5838901



#### 2 Ways to turn ON+OFF: Manual switch or Wave

Ideal when hands are dirty, wearing gloves, fishing or climbing



Spot Beam



Flood Beam

## KANGASTAR 10K

### Professional, Rechargeable LED Work Light

#### ESSENTIAL FEATURES

- 10,000 lumen Anti-Glare Scene Light
- Powered by AC or tool battery
- Optional lithium iron rechargeable battery
- Integrated stand, handle, and hanging hooks
- Brightness Control
- USB Output
- Designed for Harsh Environments
- IP 65 rated
- Rugged / Tough Aluminum Housing
- Ultra-Wide 330 ft / 100m Beam

#### Supplied with:

3 in 1 Battery Adaptor (DeWalt, Milwaukee, Metabo)

#### Optional Accessories:

AC Adaptor / Kanga Battery Charger | Rechargeable 19.2 6Ah 115.2Wh LiFe PO<sub>4</sub> Battery | 4 in 1 Battery Adaptor (Panasonic, Makita, Bosch, Hikoki)



#### Supplied

3 in 1 Battery Adaptor



#### Optional

AC Adaptor / Battery Charger  
Product #: 5838801



#### Optional

Rechargeable Battery  
Product #: 5838701



#### Optional

4 in 1 Battery Adaptor  
Product #: 5838601

#### SPECIFICATIONS

	Kanga Lite 10K
	10,000
	Up to 328 ft. / 100m
	1.5 - 7.5 hours (6Ah battery)
<b>MODE</b>	20% / 40% / 60% / 80% / 100%
<b>MATERIAL</b>	Aluminum, PC, POM, Silicon Rubber
	2 hours charging time
	IP65
	10.4 x 5.7 x 14.2 in. / 265 x 145 x 360mm
	6.6 lb. / 3 kg
<b>CODE</b>	5838501



**Brighter and higher quality beam of light with COB LED**





Designed for harsh environments with ultra-wide 330 ft / 100m beam



Portable and cable free providing complete flexibility and continuous light



Rugged and tough design with IP65 rated enclosure



Up to 7.5 hour runtime and 2 hour charging time

19.2 V 6Ah 115.2Wh

Rubber coating shockproof

IP65

LiFePO4 batteries

- Super Stability  
No Fire  
No Explosion
- 2000+ cycle
- Long lifespan

The shockproof rubber bumper and stable universal LiFePO<sub>4</sub> battery eliminates fires and explosions

Powered by 7 of the most popular power tool batteries

Power tool adaptors



Dewalt 14.4V & 18V

Panasonic 14.4V & 18V

Milwaukee 14.4V & 18V

Hikoki 14.4V & 18V

Metabo 14.4V & 18V

Makita 14.4V & 18V

Bosch 14.4V & 18V



Hanging hooks for convenient operation



Optional 11.5 ft. / 3.5m Tripod  
Product #: 5837001



The AC adaptor also serves as the battery charger



Convex lens for improved light beam



Brightness Control

USB power bank  
charges your device

On/Off Button

Battery

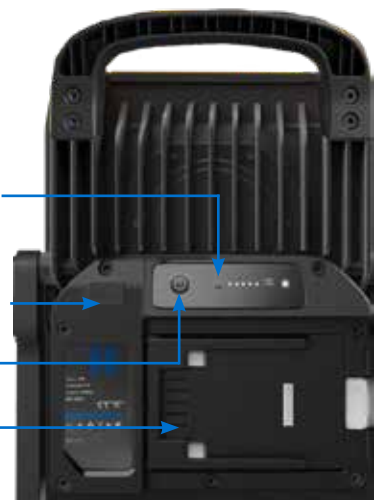

## WORKSTAR CONNECT

**Work light designed to operate from rechargeable power tool batteries**

### ESSENTIAL FEATURES

- 3 light modes - high, medium, low
- Beam Distance up to 82 ft. / 25m
- Run Time - up to 16 hours
- Powerful 2,500 lumens
- Tripod mountable
- Toughened glass lens
- IP54 and IK07 shock proof Rating
- 4 X Powerful magnetic feet
- Adjustable stand with hanging hook
- Operates from power tool batteries
- Compact, fold flat design
- USB power bank

### Supplied with:

4 x Power Tool Adaptors accepting the following battery brands: Black & Decker | Bosch | Makaita | Stanley | Dewalt | Porter | Milwaukee (14-21V batteries not included)



Adjustable stand with hanging hook

### SPECIFICATIONS

	WorkStar Connect
	2,500
	Up to 82 ft. / 25m
	2-16 hours (18-21V) battery
<b>MODE</b>	High / Medium / Low
	IP54
	8.9 x 3.5 x 13.4 in. / 225 x 90 x 340mm
	2.2 lb. / 1 kg
<b>CODE</b>	5847301



Ultra powerful magnetic base





BOSCH  
BLACK &  
DECKER  
STANLEY



MAKITA  
MILWAUKEE  
DEWALT



USB power bank charges your work light on the go

Adjustable  
angle



Hanging hook

4 Magnetic feet



## SINGLE PULSAR-AAA

### LED Hazard Warning Lights

#### ESSENTIAL FEATURES

- Shockproof and magnetic housing
- Extremely robust and compact
- IP67 weatherproof rating
- Withstands weights up to 2,000 lbs.
- Fold away hanging hook

#### Supplied with:





3 x AAA batteries

#### Optional Accessories:

Cone Mount: 5837101



#### SPECIFICATIONS

Pulsar-AAA	
	Up to 240 hours depending on mode
	IP67
	1.3 x 4.3 in. / 34 x 110mm
	.38 lb. / 170 g
CODE	Red 5847401
	Blue 5847501
	Green 5847601
	Yellow 5847701



Optional cone mount:  
Product #: 5838401

Fold away  
hanging hook

#### Run times for light modes:

Rotate	52 Hours	Quad Flash	120 Hours
Single Blink	240 Hours	Alternating Blinks	18 Hours
SOS Rescue	22 Hours	Steady on High	10 Hours
Steady on Low	25 Hours	2 LED Lights	52 Hours
4 LED Lights	25 Hours	White Torch Mode	60 Hours

#### Millicandela (MCD)

Red	6,000
Blue	11,000
Green	7,000
Yellow	7,500



Crushproof up to 2,000 lbs.

## PI LIT

### LED Hazard Warning Lights

#### ESSENTIAL FEATURES

- Shockproof and magnetic housing
- Extremely robust and compact
- IP66 weatherproof rating
- Withstands weights up to 2,000 lbs.
- Fold away hanging hook

#### Supplied with:

Carrying case | DC 12/24V Vehicle Plug |  
AC 110/240V Wall Plug

#### Optional Accessories:

Cone Mount: xxxxx



#### SPECIFICATIONS

Pulsar-AAA	
	Up to 240 hours depending on mode
	IP67
	1.3 x 4.3 in. / 34 x 110mm
	.38 lb. / 170 g
CODE	Red 5847401
	Blue 5847501
	Green 5847601
	Yellow 5847701

Run times for light modes:			
Rotate	52 Hours	Quad Flash	120 Hours
Single Blink	240 Hours	Alternating Blinks	18 Hours
SOS Rescue	22 Hours	Steady on High	10 Hours
Steady on Low	25 Hours	2 LED Lights	52 Hours
4 LED Lights	25 Hours	White Torch Mode	60 Hours

Millicandela (MCD)	
Red	6,000
Blue	11,000
Green	7,000
Yellow	7,500



Optional cone mount:  
Product #: 5838401

Fold away  
hanging hook



Crushproof up to 30,000 lbs.



# CONTACT YOUR SALES REPRESENTATIVE TODAY

The Will-Burt Company, headquartered in Orrville, Ohio, USA, is the world's premier manufacturer of mobile telescoping masts, towers and pan and tilt positioners. We offer virtually every mobile payload elevation and integration solution for defense, government, first responders, cellular and mobile, broadcast, energy production and other markets. Will-Burt also offers contract manufacturing, metal fabrication, powder-coating, and rapid prototyping services. Will-Burt is an international company with offices and manufacturing in the USA, England, and Germany along with offices in Singapore and a joint venture in Turkey. All Will-Burt Company manufacturing locations are backed by a certified ISO 9001:2015 Quality Management System. Incorporated in 1918, Will-Burt is 100% employee-owned and is classified as a small business.



## WILL-BURT NORTH AMERICA WORLD HEADQUARTERS

401 Collins Blvd., Orrville, OH USA 44667  
Telephone: +1 330 682 7015  
Mast Customer Service: +1 330 684 4000  
Fax: +1 330 684 1190  
Email: [info@willburt.com](mailto:info@willburt.com)

## WILL-BURT GERMANY

Fischergasse 25  
D-91344 Waischenfeld  
Germany  
Telephone: +49 9202 180  
Fax: +49 9202 1811  
Email: [info@willburt.com](mailto:info@willburt.com)

## WILL-BURT UNITED KINGDOM

Unit 5b, Station Approach  
Four Marks, Alton Hampshire,  
GU34 5HN, United Kingdom  
Telephone: +44 (0) 1403 265532  
Fax: +44 (0) 1403 259072  
Email: [info@willburt.com](mailto:info@willburt.com)

## WILL-BURT ASIA SINGAPORE SALES OFFICE

1 Fullerton Road, #02-01 One Fullerton,  
Singapore 049213  
Telephone: +65 6832 5689  
Fax: +65 6722 0664  
Email: [info@willburt.com](mailto:info@willburt.com)

## INTEGRATED TOWER SYSTEMS A WILL-BURT COMPANY

2703 Dawson Road, Tulsa, OK 74110  
Telephone: +1 800 850 8535  
Fax: +1 918 749 8537  
Email: [programs@itstowers.com](mailto:programs@itstowers.com)

## WILL-BURT TURKEY

Ahi Evran OSB Mahallesi,  
Nahcivan Caddesi, No: 8/2,  
Sincan, Ankara 06935  
Email: [info@willburt.com](mailto:info@willburt.com)