

CREATING POWER SOLUTIONS.

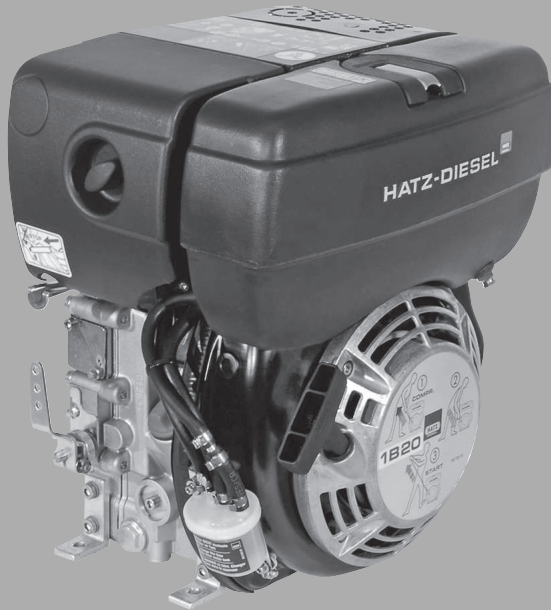

1B20 | 1B27 | 1B30 | 1B40 | 1B50

OPERATOR'S MANUAL

Diesel engine

Hatz Diesel

www.HATZ-DIESEL.com

1	Notices	5
2	General information	6
3	Safety	7
3.1	General information.....	7
3.1.1	Intended use and foreseeable misuse	7
3.1.2	Machine user or machine manufacturer obligations	8
3.1.3	Representation of safety notes	9
3.1.4	Meaning of safety symbols.....	10
3.2	Safety notes	12
3.2.1	Operational safety	12
3.2.2	Machine-specific safety instructions for operation	15
3.2.3	Machine-specific safety instructions for maintenance work	16
3.2.4	Electrical equipment.....	18
3.3	Labels.....	20
4	Technical data	22
4.1	Engine information and filling quantities.....	22
4.2	Engine type plate	23
4.3	Physical operating conditions.....	24
4.4	Engine oil	25
4.5	Fuel	26
5	Engine design.....	27
6	Transport, assembly and commissioning	29
6.1	Transport.....	29
6.2	Installation notes	30
6.3	Preparations for commissioning.....	31
6.4	Filling engine oil (first filling).....	32
6.5	Filling the oil bath air filter (option)	33
7	Operation and use.....	34
7.1	Safety notes	34
7.2	Performing tests	35
7.3	Setting the speed control	36
7.4	Starting the engine	37
7.4.1	Starting the engine with recoil start (up to -6 °C)	38
7.4.2	Starting the engine with a starter	39
7.5	Switching off the engine	43
7.5.1	Switching off the engine (mechanical)	43
7.5.2	Switching off the engine (electrical)	45
7.6	Checking the oil level and adding oil if necessary.....	47
7.6.1	Engine oil level	48
7.6.2	Oil level in the oil bath filter (option)	49

7.7	Refueling	50
7.8	Checking the water separator	52
7.9	Check the air filter warning indicator (option)	54
8	Maintenance	55
8.1	General maintenance instructions	55
8.2	Maintenance work	56
8.2.1	Maintenance notice label	56
8.2.2	Maintenance plan	57
8.2.3	Checking the intake area	59
8.2.4	Change the engine oil	60
8.2.5	Clean the oil filter	62
8.2.6	Check and set the tappet clearance	65
8.2.7	Maintaining the oil bath filter	68
8.2.8	Clean the cooling air area	70
8.2.9	Check the screw connections	73
8.2.10	Clean the exhaust screen	73
8.2.11	Changing the fuel filter	78
8.2.12	Maintaining the dry air filter	83
8.2.13	Checking and cleaning the air filter cartridge	84
9	Faults	86
9.1	Troubleshooting	86
9.2	Emergency start	91
10	Storage and disposal	93
10.1	Storing the machine	93
10.2	Disposing of the machine	95
11	Installation declaration	96

1 Notices

Contact data

© 2016
Motorenfabrik HATZ
Ernst-Hatz-Straße 16
94099 Ruhstorf
Germany
Tel. +49 (0)8531 319-0
Fax +49 (0)8531 319-418
marketing@hatz-diesel.de
www.hatz-diesel.com
All rights reserved!

Copyright

The copyright for this Operator's Manual rests entirely with Motorenfabrik HATZ, Ruhstorf.

This Operator's Manual may only be copied or distributed if written approval has been received. This also applies to the copying or distribution of excerpts of the Operator's Manual. The same conditions apply to distribution of the Operator's Manual to third parties in digital form.

Original Operator's Manual

This Operator's Manual was translated into multiple languages.

The German version is the **original Operator's Manual**. All other language versions are **translations** of the **original Operator's Manual**.

2 General information

Information on the document

This Operator's Manual was created with due care. It is exclusively intended to offer a technical description of the machine and to provide instructions on commissioning, operating and maintaining the machine. When operating the machine, the applicable standards and legal regulations as well as any in-house regulations apply.

Before commissioning, during operation and before maintenance work is begun on the machine, read the Operator's Manual carefully and keep it close by for ready access.

Machine

This Operator's Manual describes the following machine.

Machine name	HATZ diesel engine
Type number	1B20, 1B27, 1B30, 1B40, 1B50

Customer service

Have service work performed by qualified technicians only. We recommend that you work with one of the over 500 **HATZ service stations**. Trained specialists there will repair your machine with **Hatz original spare parts** and with **HATZ tools**. The global HATZ service network is at your disposal to advise you and supply you with spare parts. For the address of the **Hatz service station** nearest you, please see the directory included or visit the internet at: **www.hatz-diesel.com**

Problems may occur if unsuitable spare parts have been installed. We cannot accept responsibility for damage and secondary damage that result from this.

We therefore recommend the use of **genuine Hatz original spare parts**. These parts are manufactured according to strict Hatz specifications and achieve maximum operational reliability through their perfect fit and functionality. The order number can be found in the enclosed spare parts list or on the internet at: **www.hatz-diesel.com**

Exclusion of liability

The manufacturer cannot be held responsible for personal injury, damage to property, or damage to the machine itself caused by improper use, foreseeable misuse, or failure to follow or adequately follow the safety measures and procedures described in this Operators Manual. This also applies to changes made to the machine and the use of unsuitable spare parts.

Modifications, which serve technical improvement, are reserved.

3 Safety

3.1 General information

Introduction

This chapter contains the information you need to work safely with this machine.

To prevent accidents and damage to the machine, it is imperative that these safety instructions be followed.

Read this chapter carefully before beginning work.

3.1.1 Intended use and foreseeable misuse

Intended use

The machine described in this Operator's Manual fulfills the following functions:

- Diesel engine intended for installation in a machine or for assembly with other machines to form a machine. See chapter *11 Installation declaration*, page 96.

This engine is intended exclusively for the purpose specified and tested by the manufacturer of the machine into which the engine is installed.

Any other use is not intended and therefore not permitted. Violations compromise the safety of the personnel working with the machine. Responsibility is not accepted by Motorenfabrik HATZ for damage resulting from this situation.

The operational safety of the machine is only guaranteed if it is used as intended.

Use according to the intended purpose also includes observance of the instructions in this Operator's Manual.

Foreseeable misuse

The following is considered to be foreseeable misuse:

- Any use that varies from or extends beyond the uses specified above.
- Failure to comply with the instructions in this Operator's Manual.
- Failure to comply with the safety instructions.
- Failure to immediately eliminate malfunctions that impact safety before continuing work with the machine (working with the machine when it is not in perfect condition, either functionally or in terms of safety).
- Failure to perform the necessary inspection and maintenance work.
- Any unauthorized modification of or removal of safety equipment.
- Use of spare parts and accessories that are unsuitable or have not been approved by HATZ.
- Operation in flammable or hazardous environments.

- Operation in closed-off or poorly ventilated rooms.
- Installation of the machine in moving equipment (e.g. vehicles, trailers) or in closed rooms without additional measures to handle supply air, extract air, and exhaust gas.
- Improper operation at variance with DIN 6271 and DIN ISO 8528 (climate, load, safety).

Residual risks

Residual risks result during daily use and in association with maintenance work.

These residual risks will be pointed out in chapter 3.2.2 *Machine-specific safety instructions for operation, page 15* and in chapter 3.2.3 *Machine-specific safety instructions for maintenance work, page 16* as well as in the further contents of the manual, directly in front of the descriptions or Operating Instructions concerned.

3.1.2 Machine user or machine manufacturer obligations

Machine manufacturer obligations

If you have an engine that is not yet installed in a machine, it is imperative that you follow the **Assembly Instructions for HATZ Diesel Engines** before installing the engine. These assembly instructions contain important information on how to safely install the engine and are available at your nearest **HATZ service station**.

It is prohibited to start the engine before it is fully installed.

In addition, please note that it is prohibited to start up the machine before it has been determined that the machine into which this engine is installed fulfills all safety-related requirements and legal regulations.

User obligations

The user is obliged to operate the machine when it is in perfect condition only. The user must check the condition of the machine before use and ensure that any defects are eliminated before it is taken into service. Running the machine while identified defects exist is not permitted. The user must also ensure that all persons who work on the machine are familiar with the contents of this Operators Manual.

Obligations of the operating and maintenance personnel

Personnel assigned with operating and maintaining the machine must have read and understood the Operator's Manual or must possess the qualifications necessary for working with this equipment, acquired in training/instructional courses. No one may work with the machine without the necessary qualifications, even if for just a brief period.

The operating personnel must not be under the influence of drugs, medication or alcohol.

All work performed on the machine must be in compliance with the information provided in the Operator's Manual.

Storing the Operator's Manual

This Operator's Manual is an integral component of the machine (also when being sold). It must be stored in the direct vicinity of the machine and be accessible to personnel at all times.

3.1.3 Representation of safety notes

Overview

This machine has been designed and built according to state-of-the-art technology and the recognized safety standards. Despite these precautions, risks exist when operating the machine and during maintenance work.

These risks are identified in this manual by means of safety notes.

The safety notes precede the related description or operating step.

Structure of the safety notes

The safety notes consist of:

- Danger symbol
- signal word
- Description of danger
- Possible consequences
- Preventative measures



General danger symbol



The general danger symbol is used to identify the danger of personal injury.

Signal words





Signal words identify the magnitude of the risk and the seriousness of the possible injuries:







Danger symbol/ signal word	Meaning
 DANGER	This signal word is used to indicate imminently dangerous situations which, if not avoided, will lead to serious injury or death.
 WARNING	This signal word is used to indicate potentially dangerous situations which, if not avoided, may lead to serious injury or death.
 CAUTION	This signal word is used to indicate potentially dangerous situations which, if not avoided, may lead to minor or moderate injury.
CAUTION	This signal word, without a danger symbol, is used to indicate the risk of property damage.
NOTICE	This signal word indicates additional useful information, such as operating tips and cross references.

3.1.4 Meaning of safety symbols

Explanation of symbols

The following table describes the meanings of the safety symbols used in this Operator's Manual.

Symbol	Meaning
	Smoking, fire, and open flames are prohibited!
	Warning of personal injury!
	Warning of hot surfaces!
	Warning of flammable substances!



Symbol	Meaning
	Warning of explosive substances!
	Warning of toxic engine exhaust!
	Warning of corrosive substances!
	Warning of heavy loads!
	Warning of environmental damage!
	Comply with the Operator's Manual or additional documentation from other manufacturers or the user!
	Additional information that is useful to the reader.

3.2 Safety notes

3.2.1 Operational safety

Introduction

This chapter contains all of the important safety instructions for personal protection and for safe and reliable operation. Additional, task-related safety instructions can be found at the beginning of each chapter.

 DANGER	
	<p>Danger to life, danger of injury or danger of property damage due to failure to comply with the Operator's Manual and the safety instructions contained therein.</p> <ul style="list-style-type: none"> ▪ As the user of the machine, you must ensure that all people working on the machine are familiar with the content of this Operator's Manual. ▪ Before working on the machine, read this Operator's Manual carefully, paying special attention to the safety notes. ▪ Fulfill all required safety conditions before working on the machine. ▪ Follow all general safety instructions as well as the specific task-related safety instructions contained in the individual chapters.

Using the machine

- Only operate the machine for the purposes described in chapter 3.1.1 *Intended use and foreseeable misuse*, page 7.

Compliance with other regulations

- Adhere to the applicable accident prevention regulations of the trade associations.
- Comply with the regulations concerning the minimum safety and health requirements for the use of work equipment by workers at work.
- In addition, local safety, accident prevention and environmental regulations also apply when operating the machine.

Personal protective equipment

During operation and maintenance of the machine, personal protective equipment must be available and must be used if necessary. The required personal protective equipment is specified in the descriptions of the operating steps.

Personal protective equipment	Pictogram	Function
Safety shoes		Safety shoes offer protection against: <ul style="list-style-type: none"> ▪ Slipping ▪ Falling objects
Hearing protection		Hearing protection offers protection against ear injuries due to excessive and constant noise.
Safety gloves		Safety gloves protect the hands against injury, e.g. from battery acid.
Safety goggles (with side protection)		Safety goggles protect the eyes from flying objects (e.g. dust particles, spraying liquids, spraying acid).
Working clothes		Wear close-fitting clothing. However, it must not restrict the wearer's freedom of movement.

Warning labels and information signs on the machine

The warning labels and information signs on the machine must be followed (see chapter "Labels" 3.3 *Labels*, page 20).

The warning labels and information signs must be kept legible and must be replaced if necessary. For this purpose, contact your nearest **HATZ service station**.

Maintenance work









Maintenance work that goes beyond the scope described in this manual must only be performed by qualified technicians (see chapter 2 *General information*, page 6).

Independent maintenance work and constructional changes to the machine, especially to the safety equipment, are not permitted.

Safety equipment

Safety equipment must not be modified and must not be rendered ineffective during normal operation.

General safety instructions

 DANGER	
	<p>Danger to life and danger of injury due to failure to follow the warnings on the machine and in the Operator's Manual.</p> <ul style="list-style-type: none"> ▪ Heed the warnings on the machine and in the Operator's Manual.
 WARNING	
	<p>Danger of injury and danger of incorrect operation due to inadequate personnel qualifications.</p> <ul style="list-style-type: none"> ▪ The personnel must have read and understood this Operator's Manual or must possess the qualifications necessary for working with this equipment, acquired in training/instructional courses. ▪ Only qualified personnel is permitted to operate and maintain this machine. ▪ Failure to comply will cause the warranty to be void.
 WARNING	
	<p>Danger of injury from failure to follow the operating instructions and from performing unauthorized tasks on the machine.</p> <ul style="list-style-type: none"> ▪ Follow all instructions. ▪ Do not perform activities for which no qualification is available. Contact properly trained personnel if necessary.
 CAUTION	
	<p>Danger of injury from overloading the body.</p> <p>Lifting the machine to transport it or to move it to another location can lead to injuries (of the back, for example).</p> <ul style="list-style-type: none"> ▪ Only lift the machine with a hoist (see chapter 6.1 <i>Transport</i>, page 29).

3.2.2 Machine-specific safety instructions for operation

Introduction

The machine can pose residual risks during operation. To eliminate these risks, all persons working on the machine must follow the general and machine-specific safety instructions.

If you have an engine that is not yet installed in a machine, it is imperative that you follow the **Assembly Instructions for HATZ Diesel Engines** before installing the engine.

These assembly instructions contain important information on safe installation.

If the engine is installed in a machine or assembled with other machines to form a machine, it is prohibited to start the engine before it has been determined that the newly created machine fulfills all safety-related requirements and applicable legal regulations.



Safe operation





- Before switching on the machine, ensure that no one can be injured when the machine is started up.
- During machine operation, ensure that unauthorized persons do not have access to the area in which the machine has an impact.
- Parts of the exhaust gas system and the surface of the engine become hot during operation. Risk of injury from touching hot parts! Let the engine cool before maintenance.
- Do not refuel during operation.

Faults

- Immediately eliminate faults that compromise safety.
- Switch off the machine and do not take into service again until all faults have been eliminated.

Safety instructions for operation

 DANGER	
	<p>Danger to life from inhaling exhaust gases.</p> <p>Toxic engine exhaust gases can lead to loss of consciousness and even death in closed-off and poorly ventilated rooms.</p> <ul style="list-style-type: none"> ▪ Never operate the machine in closed-off or poorly ventilated rooms. ▪ Do not breathe in the exhaust gases.

 DANGER	
 	<p>Fire hazard from fuel.</p> <p>Leaked or spilled fuel can ignite on hot engine parts and cause serious burn injuries.</p> <ul style="list-style-type: none"> ▪ Only refuel when the engine is switched off. ▪ Never refuel in the vicinity of open flames or sparks that can cause ignition. ▪ Do not smoke. ▪ Do not spill fuel.
 CAUTION	
	<p>Danger of injury from faulty starter rope.</p> <p>A chafed starter rope can rip and cause injuries.</p> <ul style="list-style-type: none"> ▪ Before using the starter rope, check for abrasion; replace the rope if necessary.

3.2.3 Machine-specific safety instructions for maintenance work

Introduction

The machine can pose residual risks during maintenance. To eliminate these risks, all persons working on the machine must follow the general and machine-specific safety instructions.

Maintenance intervals

- Strictly adhere to the maintenance intervals.
- Check the safety equipment regularly to ensure it is in good condition and functioning properly.
- Check connections, cables and fasteners regularly to ensure they are in good condition.

Maintenance work

Maintenance work that goes beyond the scope described in this manual must only be performed by qualified technicians. We recommend that you work with one of the over 500 **HATZ service stations**.









Replacing parts

- When replacing defective components, we recommend that you use **genuine HATZ original spare parts** (see chapter 2 *General information*, page 6).
- When disposing of parts that can no longer be used, do so in accordance with local environmental regulations or send them to a recycling center.

Measures following maintenance and troubleshooting







- Securely reconnect loose electrical connections; check that the electrical components and equipment are functioning properly.
- Check the entire machine for foreign bodies; remove any foreign bodies.

Safety instructions for maintenance work

 DANGER	
	<p>Danger of explosion from flammable cleaning agents. Cleaning with benzene is an explosion hazard. It is highly flammable, can become electrostatically charged, and can generate an explosive gas/air mixture.</p> <ul style="list-style-type: none"> ▪ Use halogen-free, cold cleaners with a high flashpoint for cleaning. ▪ Comply with manufacturer's instructions.
 WARNING	
 	<p>Danger of injury from compressed air and dust particles. Eye injuries may occur when cleaning with compressed air.</p> <ul style="list-style-type: none"> ▪ Wear safety goggles.
 CAUTION	
	<p>Danger of injury if maintenance instructions are not followed.</p> <ul style="list-style-type: none"> ▪ Only perform maintenance when the engine is switched off. ▪ Protect start-up devices (crank handle, recoil start or starting key) from unauthorized access. ▪ For engines with a starter: Disconnect the negative battery terminal. ▪ When the maintenance work has been completed, ensure that all tools are removed from the machine.
 CAUTION	
	<p>Danger of burns. There is a danger of burns when working on a hot engine.</p> <ul style="list-style-type: none"> ▪ Let the engine cool before maintenance.

3.2.4 Electrical equipment

Safety notes

 DANGER	
	<p>Danger to life, danger of injury or danger of property damage due to incorrect use of batteries.</p> <ul style="list-style-type: none"> ▪ Do not place tools on the battery. ▪ Before performing work on the electrical equipment, always disconnect the negative battery terminal. ▪ Never swap the positive (+) and negative (–) battery terminals. ▪ When installing the battery, first connect the positive cable and then the negative cable. ▪ When removing the battery, first disconnect the negative cable and then the positive cable. ▪ It is imperative that you prevent short circuits and mass contact of current-carrying cables. ▪ If faults occur, check the cable connections for good contact.
 DANGER	
	<p>Danger of explosion from flammable substances.</p> <p>There is a danger of explosion from flammable gases.</p> <ul style="list-style-type: none"> ▪ Keep batteries away from open flames and incendiary sparks. ▪ Do not smoke when working with batteries.
 CAUTION	
	<p>Danger of chemical burns</p> <p>Chemical burns can occur when using batteries for the electrical operation.</p> <ul style="list-style-type: none"> ▪ Protect your eyes, skin, and clothing from corrosive battery acid. ▪ Immediately rinse areas affected by splashed acid with clear water and consult a physician if necessary.

NOTICE



- The necessary wiring diagrams are included with the machine if it is equipped with electrical equipment. Additional wiring diagrams can be requested when needed.
- We cannot be held liable for electrical equipment that is not designed according to HATZ wiring diagrams.

- Promptly replace faulty indicator lamps.
- Do not pull out the starting key during operation.
- Do not disconnect the battery while the machine is running. Resulting voltage peaks could destroy the electronic components.
- When performing a manual emergency start, leave the (possibly depleted) battery connected.
- When cleaning, do not spray the electrical equipment components with a water jet or high pressure cleaner.
- When performing welding work on the machine, disconnect the battery and place the ground clamp of the welding equipment as close as possible to the welding area. Disconnect the plug-in connection to the voltage regulator.
- The following additionally applies before starting emergency operation without the battery:
 - In models with an instrument box on the engine, disconnect the plug-in connection to the voltage regulator. Turn the starting key to pos. "0" and remove.
 - In models with an external instrument box, disconnect the plug-in connection to the instrument box.

3.3 Labels

Warning labels and information signs on the engine

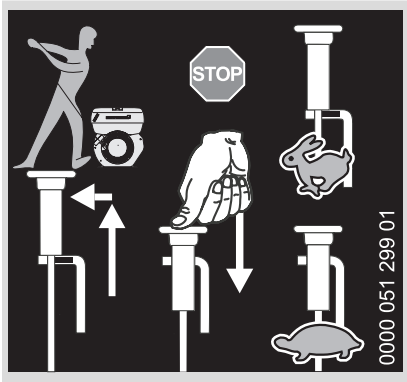
Label	Meaning
	<p>Maintenance instructions (see chapter 8.1 <i>General maintenance instructions</i>, page 55)</p>
	<p>Start the engine with the recoil start (see chapter 7.4.1 <i>Starting the engine with recoil start</i> (up to -6 °C), page 38)</p>
	<p>CAUTION Danger of injury from faulty starter rope. A chafed starter rope can snap and cause injuries.</p> <ul style="list-style-type: none"> Before using the starter rope, check for abrasion; replace the rope if necessary.

Label	Meaning
	<p>Speed adjustment with connecting rod (additional equipment)</p>
	<p>Refuel with diesel fuel only. For the specification, see chapter 4.5 <i>Fuel</i>, page 26</p> <p>Do not use bio diesel.</p>
	<p>Changing the fuel filter (see chapter 8.2.11 <i>Changing the fuel filter</i>, page 78)</p>

4 Technical data

4.1 Engine information and filling quantities

Type		1B20	1B27	1B30	1B40	1B50
Type		Air cooled four stroke diesel engine				
Combustion system		Direct injection				
Number of cylinders		1	1	1	1	1
Bore/stroke	mm	69 / 65	74 / 65	80 / 69	88 / 76	93 / 76
Displacement	cm ³	243	280	347	462	517
Tank capacity	Ltr.	3	3	5	5	5
Engine oil capacity						
Without oil sump	Approx. ltr.	0.9 ¹⁾	0.9 ¹⁾	1.1 ¹⁾	1.5 ¹⁾	1.5 ¹⁾
With oil sump	Approx. ltr.	2.6 ¹⁾	-	2.8 ¹⁾	3.2 ¹⁾	-
Difference between the "max." and "min." marks						
Without oil sump	Approx. ltr.	0.5 ¹⁾	0.5 ¹⁾	0.5 ¹⁾	0.8 ¹⁾	0.8 ¹⁾
With oil sump	Approx. ltr.	1.6 ¹⁾	-	1.8 ¹⁾	2.2 ¹⁾	-
Engine oil consumption (after running-in period)	Max.	1% of fuel consumption, pertaining to full load				
Engine oil pressure at oil temperature of 100°C	Approx.	2.5 bar at 3000 rpm				
Sense of rotation on power take-off side		Left				
Tappet clearance at 10–30°C inlet/outlet	mm	0.20	0.10	0.10	0.10	0.10
Max. perm. inclination during continuous operation in direction		Flywheel low 25° ²⁾ Other directions 35° ²⁾				
Weight (incl. fuel tank, air filter, silencer, recoil start and electric start)	Approx. kg	33	34	40	55	56
Battery capacity	Min/max	12 V – 36/55 Ah/24 V – 24/44 Ah				

¹⁾ These values are approximations only. The max. mark on the dipstick is decisive in any case (see chapter 7.6 *Checking the oil level and adding oil if necessary*, page 47).

²⁾ Exceeding these values will cause engine damage.

Screw tightening torque

Designation	Nm
Oil drain screw	50

4.2 Engine type plate

EMISSION CONTROL INFORMATION

MOTORENFABRIK HATZ AG KG · D-94099 RUHSTORF

ENG.FAM. MADE IN GERMANY mm³/H

①

TYPE / SPEC. / FDT

②

SERIAL NO. Liter / PV

③ ⑥

MIN⁻¹ NH / kW BUILD DATE

④ ⑦ ⑤

This engine conforms to MY U.S. EPA regulations large nonroad compression-ignition engines and MY California regulation for off-road compression-ignition engines. Refer to Owner's manual for maintenance specifications and adjustments.

EC-TYPE NO. ①

CONSTANT-SPEED ONLY ⑧ VARIABLE SPEED ⑨

The engine type plate is located on the sound protection hood and contains the following engine information:

1	Number of the engine family or the EU approval (for engines with exhaust certificate only)
2	Engine type, customer specification and setting of pumping start (° crankshaft before top dead center)
3	Engine serial number
4	Max. engine speed (rpm)
5	Model year
6	Displacement (liters) and inspection requirement for special settings
7	Injection pump effective stroke (mm) and engine capacity (kW)
8	"Constant speed only" (for engines with EPA/CARB exhaust certificate only)
9	"Variable speed" (for engines with EPA/CARB exhaust certificate only)

The following data must always be specified for requests and spare part orders

2	Engine type and customer specification
3	Engine serial number
4	Max. engine speed (rpm)

4.3 Physical operating conditions

Engine adjustment

The engine is normally adjusted to operate within the standard reference conditions stipulated in ISO 3046-1:

Parameter	Unit	Value
Intake air temperature	°C	+25
	K	298
Relative humidity	%	30
Air pressure (at approx. 100 meters above sea level)	kPa	100

NOTICE



If the machine is operated at high altitudes and high temperatures, adjustment of the engine setting may be necessary if the climatic conditions were not taken into account when the machine was ordered. If this is the case, please contact your nearest **HATZ service station**.

4.4 Engine oil

Oil quality

All brand name oils that satisfy at least the following specification are suitable:

- **ACEA – B3 / E4** or better
- **API – CF / CH-4** or better

If engine oils of a low quality standard are used, the oil change interval must be reduced to 150 operating hours.

Oil viscosity

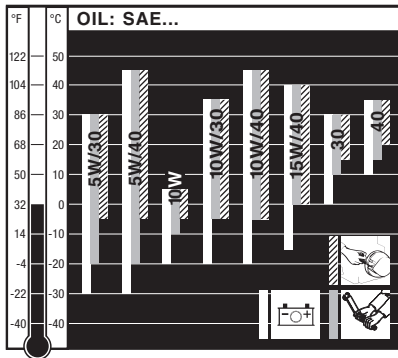

Choose the recommended viscosity based on the type of start (recoil, crankhandle or electric) and on the engine temperature at which the engine will be operated.

CAUTION

Engine damage from unsuitable engine oil.

Unsuitable engine oil considerably reduces engine service life. Only use engine oil that fulfills the specifications stipulated above.

4.5 Fuel

Fuel type

All types of diesel fuel that meet the minimum requirements of the following specifications are suitable:

- EN 590 or
- BS 2869 A1 / A2 or
- ASTM D 975- 1D / 2D

CAUTION	
	<p>Danger of engine damage from low quality fuel.</p> <p>The use of fuel that does not meet the specifications can lead to engine damage.</p> <ul style="list-style-type: none"> ▪ The use of fuel that does not meet specifications requires approval by Motorenfabrik HATZ (main plant).

Winter fuel

When outside temperatures drop below 0°C, use winter fuel or mix in petroleum in advance:

Lowest ambient temperature at start [°C]	Percentage of petroleum [%]for	
	Summer fuel	Winter fuel
0 to -10	20	-
-10 to -15	30	-
-15 to -20	50	20
-20 to -30	-	50

5 Engine design

Overview

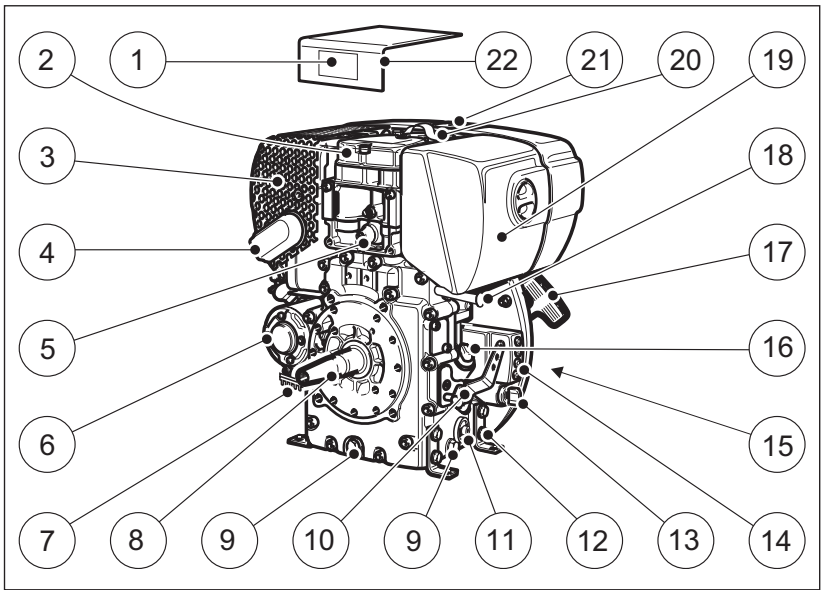

1	Type plate
2	Cylinder head cover
3	Silencer with contact protection
4	Exhaust manifold with exhaust screen
5	Oil pressure switch ¹⁾
6	Starter ¹⁾
7	Voltage regulator ¹⁾
8	Crankshaft – power take-off (pto)
9	Oil drain screw
10	Speed control lever
11	Screw cap for oil filter
12	Engine mount
13	Starting key ¹⁾
14	Indicators ¹⁾
15	Intake opening for cooling and combustion air
16	Oil filling opening and dipstick

17	Recoil start
18	Stop pin (option)
19	Dry air filter
20	Lifting eye
21	Fuel cap
22	Sound protection hood







¹⁾ Only in model with electrical equipment.

The engine can optionally be supplied with an **external** instrument box.

6 Transport, assembly and commissioning

6.1 Transport

Safety notes

 WARNING	
	<p>Danger of injury from improper lifting and transport. Danger of crushing from falling or tipping of the engine.</p> <ul style="list-style-type: none"> ▪ Only use the lifting eye already mounted on the machine for lifting. ▪ Only use a suitable hoist with a sufficient carrying capacity. ▪ Do not remain under suspended loads.
 CAUTION	
	<p>Only use the lifting eye for transporting the engine. Do not use for lifting the entire machine.</p>
 CAUTION	
	<p>Danger of injury from overloading the body. Lifting the machine to transport it or to move it to another location can lead to injuries (of the back, for example).</p> <ul style="list-style-type: none"> ▪ Only lift the machine with a hoist.
NOTICE	
	<p>Danger of environmental damage from leaking fluid. If the machine is tilted, engine oil and fuel can run out.</p> <ul style="list-style-type: none"> ▪ Only transport the machine in an upright position.

Transport conditions

- When transporting the machine, follow the safety instructions.
- When transporting, follow the applicable safety and accident prevention regulations of the trade associations.
- After delivery, check the machine for completeness and transport damage.
- Only transport the machine when it is switched off and has cooled down.
- If you have questions on transporting the machine, please contact your nearest **HATZ service station**. For contact data, see chapter 1 *Impressum*, page 5 or www.hatz-diesel.com.

Access to the lifting eye

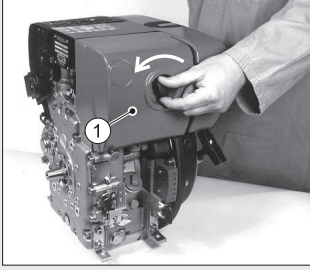
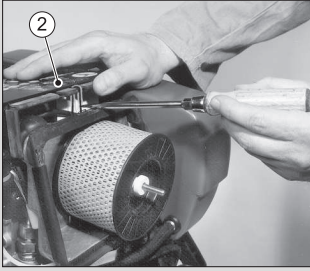
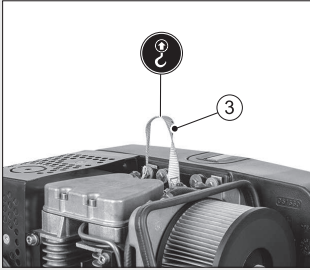
Step	Activity	Figure
1	Unscrew the air filter cover (1).	
2	Remove the sound protection hood (2).	
3	Attach the hoist securely to the lifting eye (3).	
4	After completion of transportation, refit the sound protection hood and cover for the air filter.	

6.2 Installation notes

HATZ diesel engines are efficient, robust and have a long service life. Therefore, they are usually installed in machines that are used for commercial purposes.

The machine manufacturer must follow the applicable regulations regarding machine safety – the engine is a part of a machine.

Depending on the use and installation of the engine, it may be necessary for the machine manufacturer and machine user to install safety equipment to prevent inappropriate use. Note the following:

- Parts of the exhaust gas system and the engine surface become hot during operation and may not be touched until they cool down after the engine is switched off.
- Incorrect cable connections and incorrect operation of the electrical equipment can lead to sparking and must be avoided.
- After the engine is installed in the machine, rotating parts must be protected against contact.
HATZ safety equipment is available for the belt drive of the cooling fan and alternator.
- Comply with all notices and warning labels on the engine and keep them in a legible condition. If a label should become detached or be difficult to read, it must be replaced promptly. For this purpose, contact your nearest **HATZ service station**.
- Any improper modification of the engine results in a loss of liability coverage for resulting damage.



Only regular maintenance, as specified in this Operators Manual, will maintain the operating readiness of the engine.

The **assembly instructions** contain important information on how to safely assemble the engine. They are available from any **Hatz service station**.

If you have any questions, please contact your nearest **HATZ service station** before commissioning the engine.

6.3 Preparations for commissioning



- Check the delivered parts for completeness, damage, and other noticeable issues.
- Ensure that the setup location is adequately ventilated.

 DANGER	
	<p>Danger to life from inhaling exhaust gases.</p> <p>Toxic engine exhaust gases can lead to loss of consciousness and even death in closed-off and poorly ventilated rooms.</p> <ul style="list-style-type: none"> ▪ Never operate the machine in closed-off or poorly ventilated rooms. ▪ Do not breathe in the exhaust gases.

6.4 Filling engine oil (first filling)

Engines are normally delivered without an engine oil filling.

Safety notes

⚠ CAUTION	
 	<p>Danger of injury</p> <p>Prolonged contact with engine oil can lead to irritation of the skin.</p> <ul style="list-style-type: none"> Wear safety gloves. If there is contact with the skin, thoroughly wash the affected areas of the skin with soap and water.
CAUTION	
	<p>Danger of later engine damage.</p> <ul style="list-style-type: none"> Operating the engine with an oil level below the min. mark or above the max. mark can lead to engine damage. When checking the oil level, the engine must be horizontal and have been switched off for a few minutes.

Overview

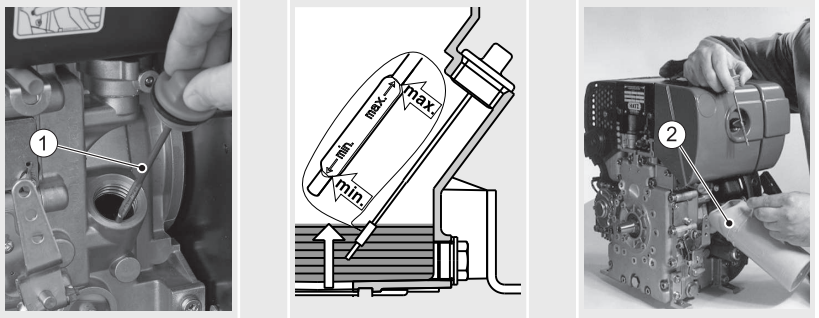

1	Dipstick
2	Oil refilling container

Procedure

Step	Activity
1	Unscrew the dipstick (1) and clean it.
2	Fill engine oil. For the specification and viscosity, see chapter 4.4 <i>Engine oil</i> , page 25. See chapter 4.1 <i>Engine information and filling quantities</i> , page 22 for the engine oil capacity.

Step	Activity
3	Reinsert the dipstick and screw it tight.
4	Unscrew the dipstick and check the oil level.
5	If required, top up engine oil to the max. mark.
6	Reinsert the dipstick and screw it tight.

6.5 Filling the oil bath air filter (option)

Overview

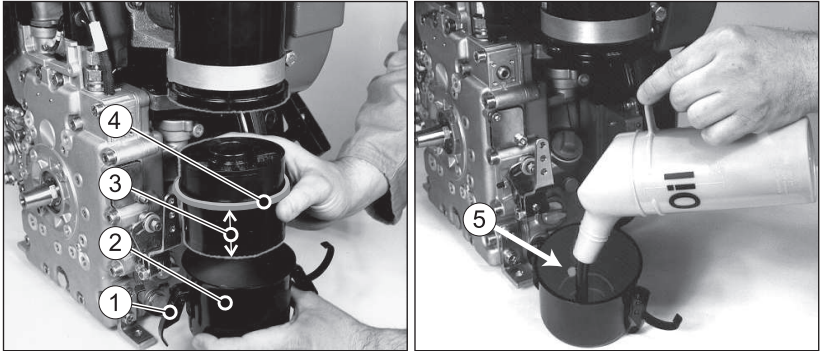

1	Clamp fastener (2x opposing)
2	Oil container
3	Filter insert
4	Gasket
5	Level mark

Procedure

Step	Activity
1	Release the clamp fasteners (1).
2	Remove the oil container (2).
3	Take the filter insert (3) out of the oil container.
4	Fill the oil container with engine oil up to the level mark (5).
2	Insert the long end of the filter insert (3) into the oil container.
3	Mount the oil container, ensuring that the gasket (4) is properly positioned and the locks (1) are correctly fastened.

7 Operation and use

7.1 Safety notes

NOTICE



Comply with the safety chapter!

Follow the basic safety instructions in chapter 3 *Safety*, page 7.



WARNING



Danger of injury from damage and defects on the machine.

- Do not take the machine into service if damage has been localized and identified.
- Replace faulty components.



WARNING



Danger of injury from failure to follow the operating instructions and from performing unauthorized tasks on the machine.

- Define the responsibilities of the personnel taking the machine into service.
- Replace faulty machine parts immediately.
- Check the installation conditions when the machine is first taken into service and after the machine has been inactive for a lengthy period.

CAUTION

Danger of engine damage from low load operation.

Operating the engine at no load or at very low load for an extended period can impair the running characteristics of the engine.

- Make sure that the engine load is at least 15 %.
- Before switching off the engine following low load operation, briefly operate it at a considerably higher load.

CAUTION

Exceeding of the permissible forces at the speed control lever and stop pin can cause damage to the stops and inside regulator parts.

Please note the following figure.

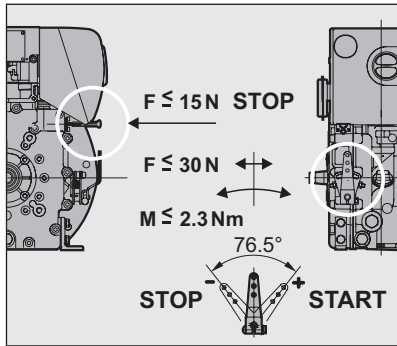
Max. permissible forces on the speed control lever and stop pin**7.2 Performing tests****Before starting**

Before starting the engine, several tests need to be performed to ensure the machine is working properly.

Procedure

Step	Test
1	The machine is standing securely and on a level surface.
2	The installation location is adequately ventilated.
3	There is a sufficient amount of fuel in the fuel tank (see chapter 7.7 <i>Refueling</i> , page 50).
4	There is a sufficient amount of engine oil in the engine housing (see chapter 7.6 <i>Checking the oil level and adding oil if necessary</i> , page 47).
5	The starter rope of the recoil start does not exhibit abrasion (hand start).
6	Fill the oil bath air filter (option) with engine oil (see chapter 7.6.2 <i>Oil level in the oil bath filter (option)</i> , page 49).
7	No persons are located in the danger zone of the engine or machine.
8	All safety equipment is in place.

7.3 Setting the speed control

Safety note

CAUTION	
	<p>Damage to the diesel engine due to inadequate lubrication.</p> <ul style="list-style-type: none"> After the engine has been out of use for an extended period (approx. 6 months or longer) or when the engine is first taken into service, operate the engine at a low set speed and without a load for approx. 20 seconds after starting. This ensures good lubrication of all bearing points before the speed and load are increased.

Overview

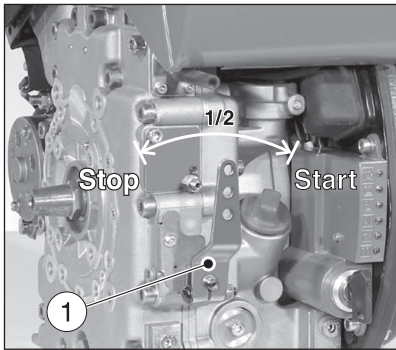

1	Speed control lever
---	---------------------

Procedure

Step	Activity
1	First move the speed control lever (1) to the "Stop" position.
2	Depending on the situation, place the speed control lever in either the "1/2" or "Start" position.

NOTICE	
	<p>A lower speed setting will cause less exhaust smoke when starting.</p>







7.4 Starting the engine

Starting options

A hand start mechanism is standard equipment for the engine. A starter can be installed as an option.

If possible, separate the engine from the machine being driven by uncoupling it. Always switch the machine into idle mode.

Safety notes

 DANGER	
	<p>Danger to life from inhaling exhaust gases.</p> <p>Toxic engine exhaust gases can lead to loss of consciousness and even death in closed-off and poorly ventilated rooms.</p> <ul style="list-style-type: none"> ▪ Never operate the machine in closed-off or poorly ventilated rooms. ▪ Do not breathe in the exhaust gases.
 WARNING	
	<p>Danger of injury from faulty starter rope.</p> <p>A chafed starter rope can rip and cause injuries.</p> <ul style="list-style-type: none"> ▪ Before using the starter rope, check for abrasion; replace the rope if necessary.
 CAUTION	
	<p>Danger of injury and danger of engine damage from the use of starting fluid.</p> <ul style="list-style-type: none"> ▪ Danger of injury during hand starting because the use of starting fluid can result in uncontrolled ignitions. ▪ Engine damage from uncontrolled ignition. ▪ Never use starting fluid.

7.4.1 Starting the engine with recoil start (up to -6 °C)

Overview

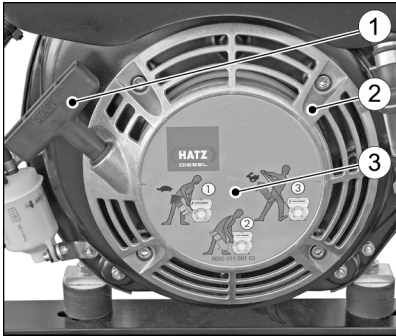

1	Grip
2	Recoil start cover
3	Diagram of starting procedure

Procedure



Step	Activity
1	Check the speed adjustment (see chapter 7.3 <i>Setting the speed control</i> , page 36).
2	Slowly pull out the grip with the rope until you encounter slight resistance.
3	Let the rope run back in to be able to use the entire rope length for the starting procedure.
4	Hold the grip with both hands.
5	Pull the starting rope evenly and with increasing speed (do not tear at it jerkily) until the engine starts.

NOTICE

When the exhaust emits white smoke after several failed start procedures:

- Move the speed controller lever to the "Stop" position.
- Pull the starting rope all the way out five times.
- Reset the speed adjustment (see chapter 7.3 *Setting the speed control*, page 36).
- Repeat the start procedure.

7.4.2 Starting the engine with a starter

Overview — HATZ instrument boxes

Standard

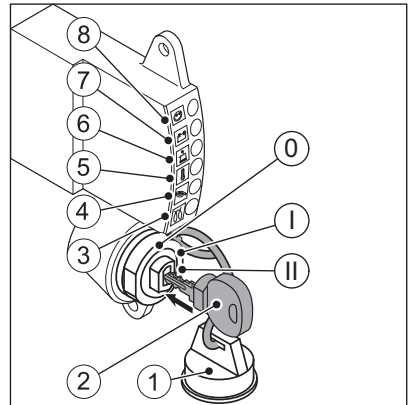
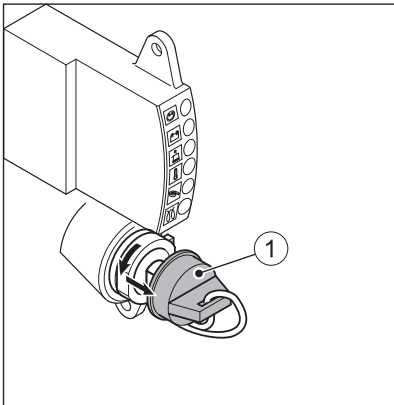

Option

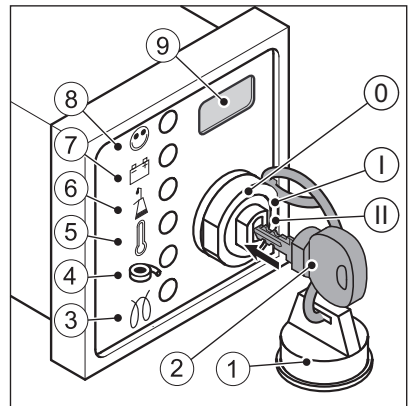
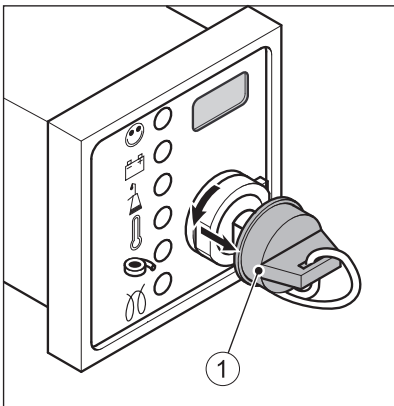





1	Protective cap
2	Starting key
3	Pre glow display (option)
4	Air filter maintenance indicator (not activated)
5	Engine temperature display (option)
6	Oil pressure display
7	Charge control
8	Operating display
9	Operating hours counter (option)
Ignition lock	
0	Off
I	Operation
II	Start

Indicator lamps

When the starting key is turned to position "I" various indicator lamps flash or light up (depending on the equipment version). If there is a fault, the applicable indicator does not go out after the engine start or it lights up again during operation.

Explanation of symbols

Symbol	Meaning
	Operating display Lights up during operation when there is no engine fault.
	Charge control Fault in the alternator or alternator charging circuit. The battery is no longer charged. Eliminate the fault immediately.
	Oil pressure display Switch off the engine immediately! Danger of engine damage. Check the oil level (see chapter 7.6 <i>Checking the oil level and adding oil if necessary</i> , page 47). Contact Hatz service if the oil level is correct.
	Engine temperature display Switch off the engine immediately! Danger of engine damage. Engine temperature is impermissibly high. For details of troubleshooting, see chapter 9.1 <i>Troubleshooting</i> , page 86.
	Pre glow display Lights at temperatures below 0°C. Start the engine when the display has gone out.

Overview – Fuel shut-off valve (option)

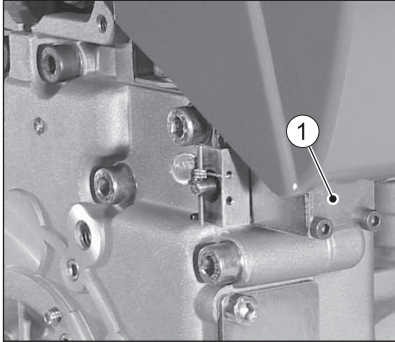

1	Fuel shut-off valve
---	---------------------

Description of functions

When the starting key is moved to **position I** the fuel shut-off valve (1) is electrically unlocked. The fuel supply to the injection pump is enabled, the engine is ready to start. When the engine is running, turning the starting key to **position 0** locks the fuel shut-off valve and thereby blocks the fuel supply to the injection pump, the engine switches off.

This fuel shut-off valve is also used in association with the electrical automatic shutoff. When faults occur the automatic shutoff switches off the engine. For troubleshooting details, see chapter *9.1 Troubleshooting, page 86*.

In special situations an **emergency start** can also be attempted (see chapter *9.2 Emergency start, page 91*).

Procedure – Starting the engine with a starter

NOTICE



- Start for max. 30 seconds. If the engine is still not running after that, turn the starting key back to position "0" and eliminate the cause (see chapter *9.1 Troubleshooting, page 86*).
- Turn the starting key to position "0" every time you want to start the engine.
- The anti repeat device in the ignition lock makes it impossible for the starter to engage while the engine is running and become damaged.

Step	Activity
1	Check the speed adjustment (see chapter <i>7.3 Setting the speed control, page 36</i>).
2	Remove the protective cap (1) from the ignition lock.

Step	Activity
3	Insert the starting key all the way and turn to position "I". When the pre glow display (3) lights up, wait until it goes out then continue with step 3.
4	Turn the starting key to position "II".
5	As soon as the engine is running, release the starting key. <ul style="list-style-type: none"> ▪ The starting key springs back to position "I" and remains in this position during operation. ▪ The charge control (7) and oil pressure display (6) go out. ▪ Operating display (8) lights up and signals there is no engine fault.

NOTICE



- In case of irregularities, switch off the engine immediately.
- Identify the fault and eliminate it.
- For details of troubleshooting, see chapter 9.1 *Troubleshooting*, page 86.

Automatic electrical shutoff (option)

The identifying feature of the electrical automatic shutoff is brief flashing of all indicator lamps after the starting key is turned to position "I".

NOTICE





- If the engine stops again immediately after starting, or stops independently during operation, this is an indication that a monitoring element of the automatic shutoff has been activated.
- Remedy the fault before making further starting attempts (see chapter 9.1 *Troubleshooting*, page 86).
- Despite the automatic switch-off, check the oil level every 8–15 operating hours (see chapter 7.6 *Checking the oil level and adding oil if necessary*, page 47).

Procedure when faults occur

Step	Activity
1	Check the indicators (5-7). After the engine comes to a standstill, the fault will continue to be displayed by the indicator for approx. another 2 minutes.
2	Then the electrical equipment switches off automatically.
3	Set the starting key to position "0".

Step	Activity
4	<p>Turn the starting key back to position "I".</p> <p>The fault display lights up again.</p> <p>Remedy the fault before making further starting attempts (see chapter 9.1 <i>Troubleshooting</i>, page 86).</p> <p>The indicator then goes out at the next start.</p>

7.5 Switching off the engine

 CAUTION	
	<p>Danger of injury from unauthorized access.</p> <p>There is a danger of injury if unauthorized persons handle the machine.</p> <ul style="list-style-type: none"> Protect the starting key against unauthorized access during breaks in operation or after completing work.
CAUTION	
	<p>Protect the ignition lock against dirt and moisture.</p> <ul style="list-style-type: none"> With the starting key pulled out, seal the ignition lock with the protective cap.

Methods of switching off the engine

The engine can be switched off in different ways depending on how it is equipped:

- Speed control lever (mechanical)
- Stop pin (mechanical)
- Starting key (electrical)

7.5.1 Switching off the engine (mechanical)

NOTICE	
	<p>Engines with a blocked lower idle speed cannot be switched off with the speed control lever. In this case, the engine is switched off with the stop pin or starting key, depending on how the engine is equipped.</p>

Overview

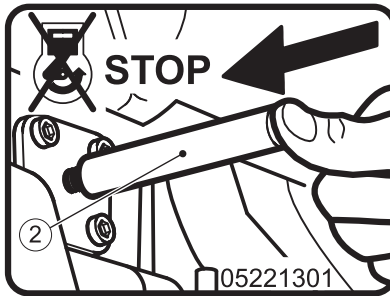
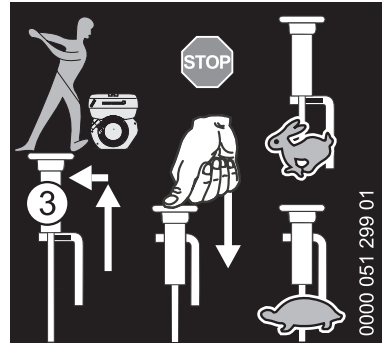
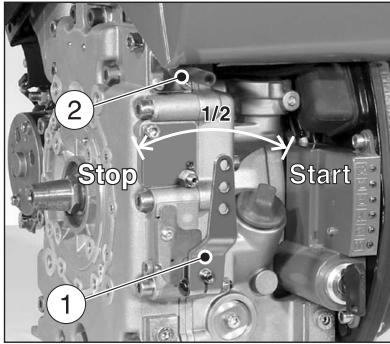

1	Speed control lever
2	Stop pin (additional equipment)
3	Connecting rod (additional equipment)

Procedure

Step	Activity
Speed control lever	
1	Push the speed control lever (1) all the way to the "STOP" position. The engine switches off.
Stop pin	
1	Press and hold the stop pin (2) until the engine switches off.
2	Release the stop pin and ensure that it returns to its original position.
Speed adjustment with connecting rod (additional equipment)	
1	Move the speed adjustment with the connecting rod (3) to the "STOP" position and press it until the engine switches off.

7.5.2 Switching off the engine (electrical)

Overview — HATZ instrument boxes

Standard

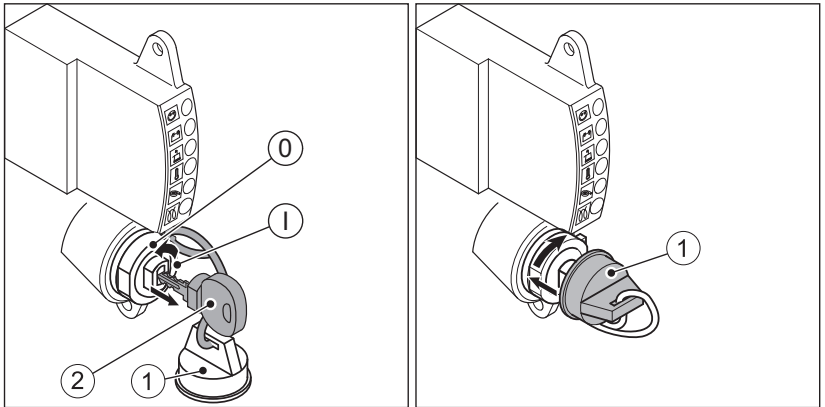

Option

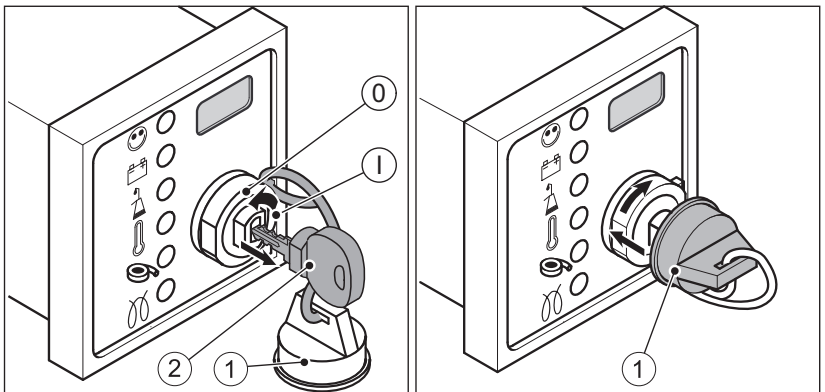

Fuel shut-off valve

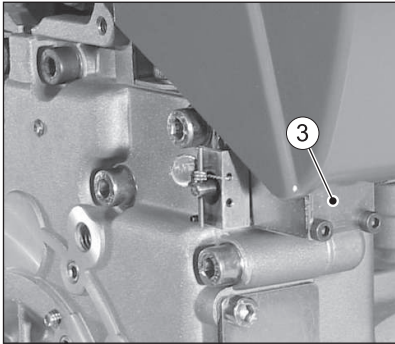

1	Protective cap
2	Starting key
3	Fuel shut-off valve
Ignition lock	
0	Off
I	Operation

Procedure

Step	Activity
1	Turn the starting key (2) to position "0". <ul style="list-style-type: none"> ▪ The fuel shut-off valve shuts off the fuel supply to the injection pump. The engine switches off. ▪ All indicator lamps go out.
2	Remove the starting key.
3	Seal the ignition lock with the protective cap (1).

NOTICE









Danger of exhaustive battery discharge.

- When the machine is switched off, always turn the starting key to position "0" or else the battery may become fully discharged.

7.6 Checking the oil level and adding oil if necessary

Safety notes

 CAUTION	
 	<p>Danger of burns.</p> <p>There is a danger of burns when working on a hot engine.</p> <ul style="list-style-type: none"> ▪ Wear safety gloves.
 CAUTION	
 	<p>Danger of injury</p> <p>Prolonged contact with engine oil can lead to irritation of the skin.</p> <ul style="list-style-type: none"> ▪ Wear safety gloves. ▪ If there is contact with the skin, thoroughly wash the affected areas of the skin with soap and water.
CAUTION	
	<p>Danger of later engine damage.</p> <ul style="list-style-type: none"> ▪ Operating the engine with an oil level below the min. mark or above the max. mark can lead to engine damage. ▪ When checking the oil level, the engine must be horizontal and have been switched off for a few minutes.

7.6.1 Engine oil level

Overview

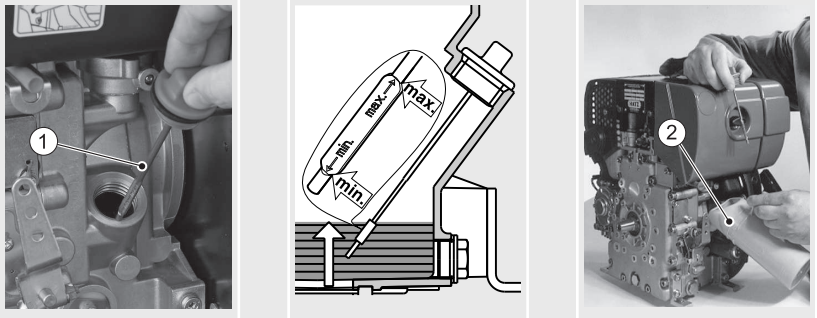

1	Dipstick
2	Oil refilling container

Procedure

Step	Activity
1	Switch off the engine and wait several minutes for the engine oil to collect in the crankcase. Engine must be level.
2	Remove contamination on the engine in the area of the dipstick.
3	Unscrew the dipstick and clean it.
4	Reinsert the dipstick and screw it tight.
5	Unscrew the dipstick and check the oil level.
6	If the oil level is close to the min. mark, add engine oil to the max. mark.
7	Reinsert the dipstick and screw it tight.

7.6.2 Oil level in the oil bath filter (option)

Overview

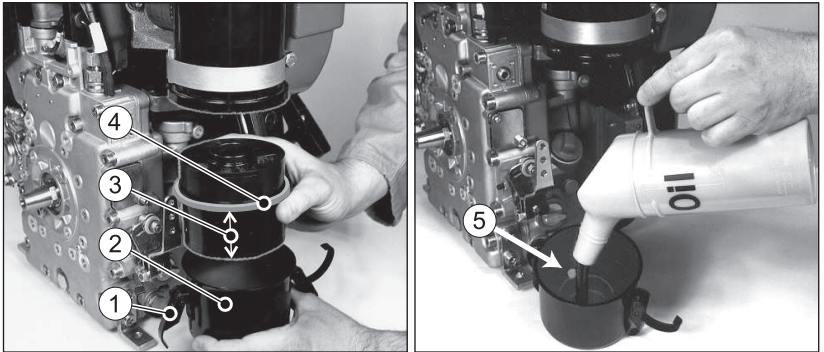





1	Clamp fastener (2x opposing)
2	Oil container
3	Filter insert
4	Gasket
5	Level mark

Procedure

Step	Activity
1	Release the clamp fasteners (1).
2	Remove the oil container (2).
3	Take the filter insert (3) out of the oil container.
4	Check for dirt. When the deposited dirt has reached approximately half the height of the oil filling or the oil has become viscous, clean the oil bath air filter (see chapter 8.2.7 <i>Maintaining the oil bath filter, page 68</i>).
4	Otherwise check the oil level and fill with engine oil up to the level mark (5) as required.
5	Mount the oil container, ensuring that the gasket (4) is properly positioned and the clamp fasteners (1) are correctly fastened.

7.7 Refueling

Safety notes

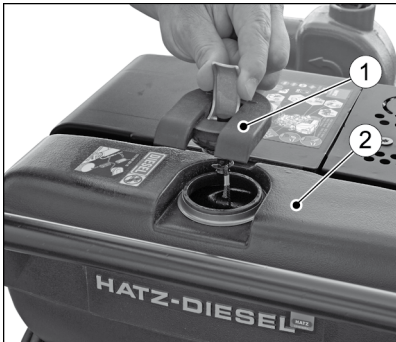

 DANGER	
 	<p>Fire hazard from fuel. Leaked or spilled fuel can ignite on hot engine parts and cause serious burn injuries.</p> <ul style="list-style-type: none"> ▪ Only refuel when the engine is switched off. ▪ Never refuel in the vicinity of open flames or sparks that can cause ignition. ▪ Do not smoke. ▪ Do not spill fuel.
 CAUTION	
	<p>Danger of environmental damage from spilled fuel. Do not overfill the fuel tank and do not spill fuel.</p> <ul style="list-style-type: none"> ▪ Collect any leaking fuel and dispose of it according to local environmental regulations.
CAUTION	
	<p>Engine damage from using low quality fuel. The use of fuel that does not meet the specifications can lead to engine damage.</p> <ul style="list-style-type: none"> ▪ Only use the fuel specified in chapter 4.5 <i>Fuel</i>, page 26. ▪ The use of fuel that does not meet specifications requires approval by Motorenfabrik HATZ (main plant).

Overview



1	Fuel cap
2	Fuel tank

Procedure

Step	Activity	Figure
1	Open the fuel cap.	
2	Fill the fuel tank with diesel fuel.	

Step	Activity	Figure
3	Close the fuel cap.	

NOTICE

 Before starting for the first time or if the fuel system is empty, fill the fuel tank fully with diesel fuel. This causes the fuel system to be bled automatically.

- Automatic bleeding is completed after a waiting period of 1-2 minutes. The engine is ready to start.

7.8 Checking the water separator

Safety notes

 **CAUTION**

 **Danger of environmental damage from spilled fuel.**

When water is drained from the water separator, a small amount of fuel is drained as well.

- Collect any escaped water/fuel mixture and dispose of it according to local environmental regulations.

NOTICE

 The interval for checking the water separator depends entirely on the proportion of water in the fuel and on the care exercised during refueling; the water separator should be checked at least once a week.

Overview

Water in the fuel tank collects at the lowest point of the fuel tank in the water separator.

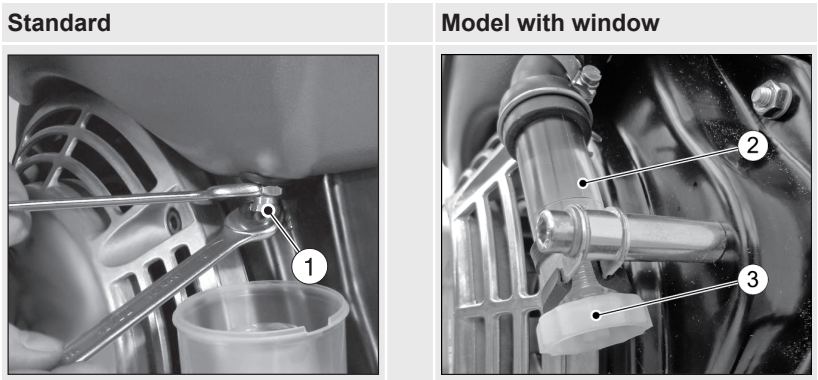

1	Drain screw, hex (standard)
2	Window (additional equipment)
3	Drain screw (manually operated)

Procedure

Step	Activity
1	Model with window: Check the window (2) for water content. Collected water can be clearly identified by the noticeable separating line between the water and the diesel fuel above it.
2	Place a suitable container under the drain screw (1) or (3). <i>NOTE:</i> In inaccessible locations, an extension hose can be mounted on the drain screw (3).
3	Open the drain screw (1) or (3) and drain the water into the container.
4	When fuel emerges, close the drain screw.
5	Dispose of the water-fuel mixture in an environmentally compatible manner.

7.9 Check the air filter warning indicator (option)

Overview

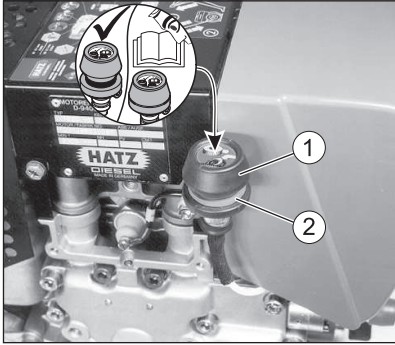

1	Rubber bellow
2	Green field



Procedure

Step	Activity
1	Bring the engine briefly to maximum speed.
2	When the rubber bellow (1) contracts and covers over the green field (2), immediately check the air filter system (see chapter 8.2.12 <i>Maintaining the dry air filter</i> , page 83).
3	Check the rubber bellow (1) several times daily under dusty conditions.

8 Maintenance

8.1 General maintenance instructions

Safety notes

 WARNING	
	<p>Danger of injury from failure to follow the operating instructions and from performing unauthorized tasks on the machine.</p> <ul style="list-style-type: none"> ▪ Follow all instructions. ▪ Do not perform activities for which no qualification is available. Contact properly trained personnel if necessary.

NOTICE	
	<p>Comply with the safety chapter!</p> <p>Follow the basic safety instructions in chapter 3 <i>Safety</i>, page 7.</p>

- Maintenance tasks may only be performed by trained personnel.
- Accident prevention measures must be in accordance with the local accident prevention regulations.
- Perform setting and maintenance work at the specified intervals.
- Replace faulty machine parts as soon as possible.
- Always use personal protective equipment.
- Only use fully functional tools.
- Problems may occur if unsuitable spare parts have been installed. We cannot accept responsibility for damage and secondary damage that result from this. We therefore recommend the use of **genuine Hatz original spare parts**.
- Closely adhere to the maintenance conditions prescribed in this Operators Manual.
- Only make changes on the machine in agreement with the manufacturer.
- Only perform maintenance when the engine is switched off.
- Protect start-up devices (crank handle, recoil start or starting key) from unauthorized access.
- After completing maintenance work, check that all tools, bolts, aids, and other objects are removed from the machine and that all safety equipment has been replaced.
- Before starting, ensure that no persons are located in the danger zone of the engine or machine.

- Adhere to legal regulations when handling and disposing of used oil, filters, and cleaning agents.
- For engines with an electric starter: Disconnect the negative battery terminal before carrying out maintenance work.



Performance of maintenance work

The entire machine is designed to be maintenance friendly. Parts that require maintenance are easily accessible.

- Perform maintenance work faithfully at the specified intervals to prevent premature wear of the machine.
- Follow the notice and warning labels on the machine.
- Always retighten screw connections loosened during maintenance work.
- After the necessary maintenance and repair work is completed, perform a function test (test run).
- For maintenance work that is not listed and described in the maintenance documentation, please contact your nearest **HATZ service station**.

8.2 Maintenance work

Safety note

 CAUTION	
	<p>Danger of injury if maintenance instructions are not followed.</p> <ul style="list-style-type: none"> ▪ Only perform maintenance when the engine is switched off. ▪ Protect start-up devices (crank handle, recoil start or starting key) from unauthorized access. ▪ For engines with a starter: Disconnect the negative battery terminal. ▪ When the maintenance work has been completed, ensure that all tools are removed from the machine.

8.2.1 Maintenance notice label

NOTICE	
	<p>The illustrated maintenance label is delivered with every engine.</p> <ul style="list-style-type: none"> ▪ It should be mounted on the engine or machine in a clearly visible location. ▪ The maintenance intervals specified on the maintenance plan must be adhered to (see chapter 8.2.2 <i>Maintenance plan, page 57</i>)

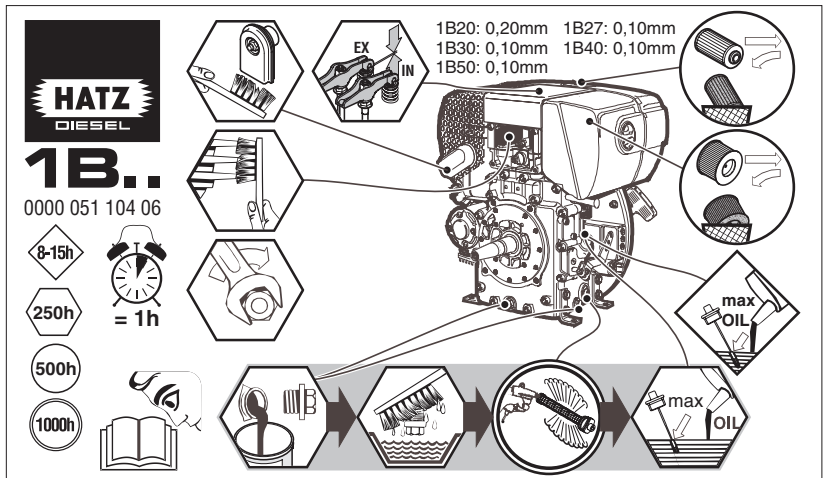



8.2.2 Maintenance plan

In new and generally overhauled engines, after **25 operating hours**:

- Change the engine oil
- Check the tappet clearance and adjust if necessary
- Checking the screw connections (do not retighten the screws for attaching the cylinder head)

In case of a low number of operating hours, change the engine oil no later than every 12 months, regardless of the actual number of operating hours.





The interval at which maintenance work should be performed on the fuel filter depends on the cleanliness of the fuel in use and may need to be shortened to 250 operating hours.

Symbol	Maintenance interval	Maintenance activity/check	Chapter
	Every 8–15 operating hours or every day before starting	Check the oil level.	<i>7.6 Checking the oil level and adding oil if necessary, page 47</i>
		Check the engine oil level in the bottom section of the oil bath filter and examine the oil for contamination. Change the oil if it is sludgy.	<i>7.6.2 Oil level in the oil bath filter (option), page 49</i>
		In models with a cyclone pre-cleaner: remove the dust trap.	<i>8.2.12 Maintaining the dry air filter, page 83</i>
		Check the intake area of the combustion and cooling air.	<i>8.2.3 Checking the intake area, page 59</i>
		Check the air filter maintenance indicator.	<i>7.9 Check the air filter warning indicator (option), page 54</i>
	Weekly	Check the water separator.	<i>7.8 Checking the water separator, page 52</i>
	Every 250 operating hours	Maintain the oil bath filter.	<i>8.2.7 Maintaining the oil bath filter, page 68</i>
		Change the engine oil.	<i>8.2.4 Change the engine oil, page 60</i>
		Check and set the tappet clearance.	<i>8.2.6 Check and set the tappet clearance, page 65</i>
		Clean the cooling air area.	<i>8.2.8 Clean the cooling air area, page 70</i>
		Check the screw connections.	<i>8.2.9 Check the screw connections, page 73</i>
		Clean the exhaust screen.	<i>8.2.10 Clean the exhaust screen, page 73</i>



Symbol	Maintenance interval	Maintenance activity/check	Chapter
500h	Every 500 operating hours	Change the fuel filter.	8.2.11 <i>Changing the fuel filter, page 78</i>
		Maintain the dry air filter.	8.2.12 <i>Maintaining the dry air filter, page 83</i>
1000h	Every 1000 operating hours	Clean the oil filter.	8.2.5 <i>Clean the oil filter, page 62</i>

8.2.3 Checking the intake area

Safety notes

 CAUTION	
 	<p>Danger of burns.</p> <p>There is a danger of burns when working on a hot engine.</p> <ul style="list-style-type: none"> ▪ Let the engine cool. ▪ Wear safety gloves.
NOTICE	
	<p>In case of heavy contamination, shorten the maintenance intervals accordingly (see chapter 8.2.2 <i>Maintenance plan, page 57</i>).</p>

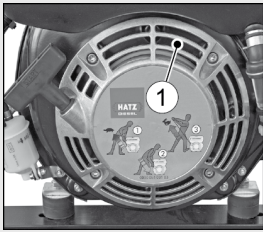
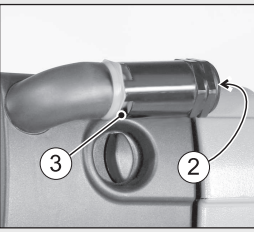
Overview

Standard	Model with cyclone precleaner	Model with oil bath filter
		
1		
Air intake opening		





2	Intake area of cyclone precleaner
3	Dust outlet opening
4	Intake area of oil bath filter

Procedure

Step	Activity
1	Check the air intake opening (1) for coarse contamination such as leaves, heavy dust deposits, etc., and clean if necessary.
2	In models with a cyclone precleaner , also check and if necessary clean the intake area (2) in addition to step 1. Check that the dust outlet opening (3) is clear and clean it if necessary.
3	In models with an oil bath filter , also check and if necessary clean the intake area (4) in addition to step 1.

8.2.4 Change the engine oil

Safety notes

 CAUTION	
 	<p>Danger of burns.</p> <p>When working on the engine there is a danger of burns from hot oil.</p> <ul style="list-style-type: none"> Wear personal protective equipment (gloves).
 CAUTION	
	<p>Danger of environmental damage from spilled used oil.</p> <p>Used oil is water-polluting.</p> <ul style="list-style-type: none"> Do not allow it to enter the ground water, water bodies, or sewage system. Collect the used oil and dispose of it according to local environmental regulations.

CAUTION
**Danger of injury**

Prolonged contact with engine oil can lead to irritation of the skin.



- Wear safety gloves.
- If there is contact with the skin, thoroughly wash the affected areas of the skin with soap and water.

CAUTION**Danger of later engine damage.**

- Operating the engine with an oil level below the **min.** mark or above the **max.** mark can lead to engine damage.
- When checking the oil level, the engine must be horizontal and have been switched off for a few minutes.

NOTICE

- The engine must be level.
- The engine must be switched off.
- Only drain engine oil while it is warm.

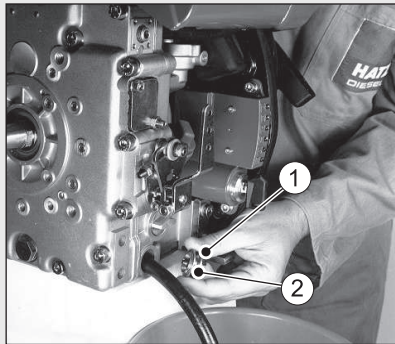
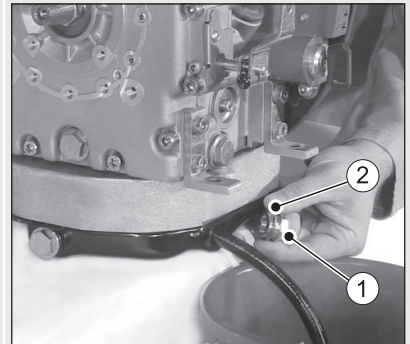
Overview**Without oil sump****With oil sump**









1	Oil drain screw
2	Gasket

Procedure

Step	Activity
1	Keep a container ready for collecting the used oil. The container must be large enough to hold the entire amount of engine oil.
2	Unscrew the oil drain screw (1) and drain the oil entirely.
3	Clean the oil filter when required (every 1000 hours of operation), see chapter 8.2.5 <i>Clean the oil filter</i> , page 62.
4	Screw in the cleaned oil drain screw (1) with the new gasket (2) and tighten. Tightening torque: 50 Nm.
5	Add engine oil (see chapter 4.4 <i>Engine oil</i> , page 25).

8.2.5 Clean the oil filter

Safety notes

 CAUTION	
	<p>Danger of burns.</p> <p>There is a danger of burns when working on a hot engine.</p> <ul style="list-style-type: none"> Let the engine cool before maintenance.
 CAUTION	
 	<p>Danger of injury</p> <p>Prolonged contact with engine oil can lead to irritation of the skin.</p> <ul style="list-style-type: none"> Wear safety gloves. If there is contact with the skin, thoroughly wash the affected areas of the skin with soap and water.
 CAUTION	
 	<p>Danger of injury.</p> <p>When working with compressed air, foreign bodies may fly into your eyes.</p> <ul style="list-style-type: none"> Wear safety goggles. Never direct the compressed air jet toward people or toward yourself.

NOTICE

- Capture emerging oil in a suitable container.
- Dispose of the oil according to legal regulations.

NOTICE

- The oil filter should be cleaned when the engine oil is changed (see chapter 8.2.4 *Change the engine oil, page 60*), since oil will run out when the filter is pulled out.



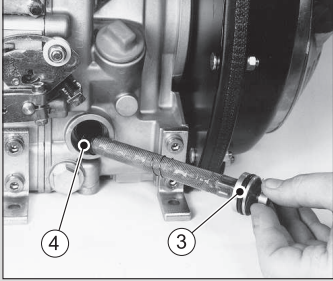
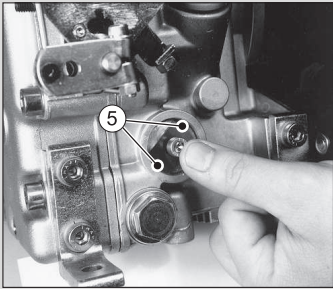

Procedure

Step	Activity	Figure
1	Loosen the screw (1) by approx. five turns.	
2	Pull the oil filter (2) out of the housing.	

Step	Activity	Figure
3	Blow out the oil filter with compressed air from the inside to the outside.	
4	Check the gasket (3) for damage and renew if necessary.	
5	Lightly oil the gaskets (3+4) before mounting.	
6	Insert the oil filter and press it all the way in.	
7	Before tightening the screw, ensure that the tension springs (5) rest against the oil filter at both ends. Tighten the screw.	
8	Check the oil level and add oil to the max. mark if necessary (see chapter 7.6 <i>Checking the oil level and adding oil if necessary</i> , page 47).	

8.2.6 Check and set the tappet clearance

Safety notes

 CAUTION	
	<p>Danger of burns.</p> <p>There is a danger of burns when working on a hot engine. Only perform the settings while the engine is cold (10-30°C).</p> <ul style="list-style-type: none"> ▪ Let the engine cool.
 CAUTION	
	<p>Damage from inadequate engine cooling.</p> <p>Only operate the engine when all covers are installed.</p>

Preparations

The preparations are performed in different ways depending on how the engine is equipped:

- Preparations on engine model with dry air filter
- Preparations on engine model with oil bath filter
- Preparations on engine model with rammer operation (1B20 R)

Preparation - Engine model with dry air filter

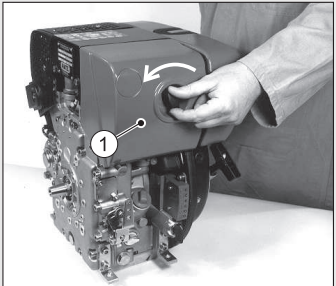
Step	Activity	Figure
1	Unscrew the air filter cover (1).	

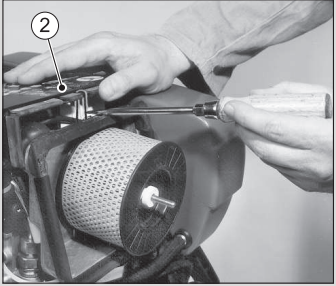
Step	Activity	Figure
2	Remove the sound protection hood (2).	

Preparation - Engine model with oil bath filter

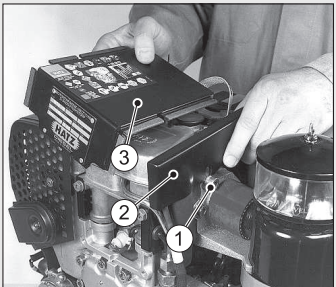
Step	Activity	Figure
1	Release the screw (1).	
2	Take off the cover plate (2) with the sound protection hood (3).	

Preparations - Engine model with rammer operation (1B20 R)

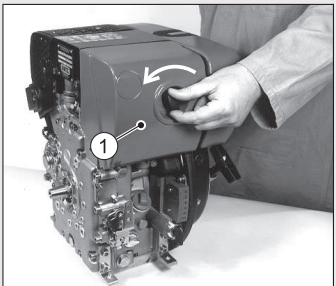
Step	Activity	Figure
1	Unscrew the air filter cap (1).	

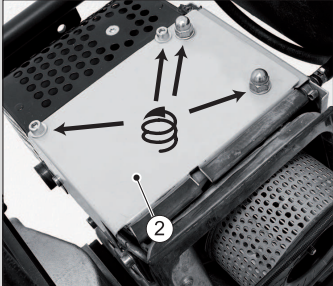
Step	Activity	Figure
2	Remove the screws and nuts. Remove the sound protection hood (2).	

Procedure

NOTICE



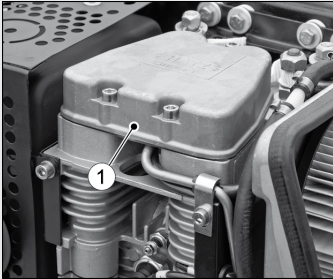
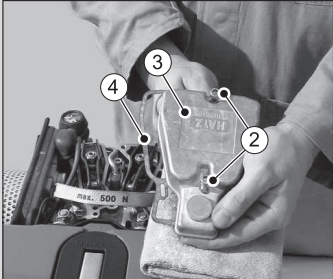

The steps described here can only be performed after the appropriate preparations have been completed.

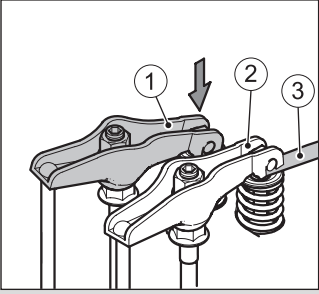
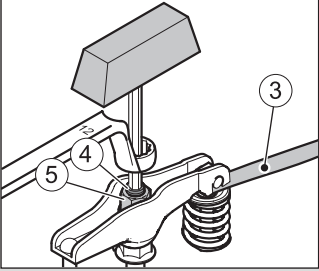
Step	Activity	Figure
1	Remove dirt in the area of the cylinder head cover (1).	
2	Remove the screws (2). (2 screws in 1B20, 1B27 and 1B30, 3 screws in 1B40 and 1B50).	
3	Take off the cover (3) with the gasket (4).	

Step	Activity	Figure
4	Turn the engine in the sense of rotation until the rocker arm (1) has fully opened the outlet valve. Then check the tappet clearance at the rocker arm (2) with a feeler gauge (3). For the setting, see the chapter 4.1 <i>Engine information and filling quantities</i> , page 22.	
5	Turn the engine in the sense of rotation until the rocker arm (2) has fully opened the intake valve. Now check the tappet clearance at the rocker arm (1).	
6	If the tappet clearance needs to be corrected: Release the screw (4) and turn the hex nut (5) so the feeler gauge (3) can be pulled through with a barely perceptible resistance after the screw (4) is tightened again.	
7	Mount the cylinder head cover with the new gasket and tighten evenly.	
8	Fully assemble the engine.	
9	Perform a test run. Check the cylinder head cover for tightness.	

8.2.7 Maintaining the oil bath filter

Safety notes

 CAUTION	
	<p>Danger of burns.</p> <p>There is a danger of burns when working on a hot engine.</p> <ul style="list-style-type: none"> Let the engine cool before maintenance.

 **CAUTION**
**Danger of injury**

Prolonged contact with engine oil can lead to irritation of the skin.



- Wear safety gloves.
- If there is contact with the skin, thoroughly wash the affected areas of the skin with soap and water.

 **CAUTION**
**Danger of injury**

Repeated contact with diesel fuel can cause chapped and cracked skin.



- Wear safety gloves.

CAUTION

- Do not repair the oil bath filter (weld/solder, etc.) as this may lead to destruction of the filter or damage to the engine.
- For model with cyclone precleaner: Never add oil to the dust trap.

Procedures

The procedure differs depending on how the engine is equipped:

- Procedure – Cleaning the cyclone precleaner
- Procedure – Cleaning the oil bath air filter





Procedure – Cleaning the cyclone precleaner

Step	Activity	Figure
1	Take off the dust collection container (1), empty it and clean it without using liquids.	
2	Also clean the intake opening (2) without liquids.	
3	Fully assemble the cyclone precleaner and tighten with the wing nut.	



Procedure – Cleaning the oil bath air filter



Step	Activity	Figure
1	Remove the oil container (1).	
2	Remove the dirty oil and sludge and clean the container.	
3	Rinse the filter insert (2) in diesel fuel. Before assembling the filter, drip or wipe dry.	
4	Clean the filter housing (3) if it is very dirty.	
5	Fully assembly the filter and prepare it for operation by filling it with oil (see chapter 7.6.2 <i>Oil level in the oil bath filter (option)</i> , page 49).	

8.2.8 Clean the cooling air area**Safety notes**

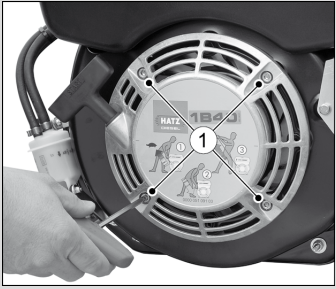
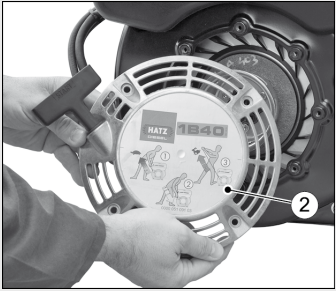
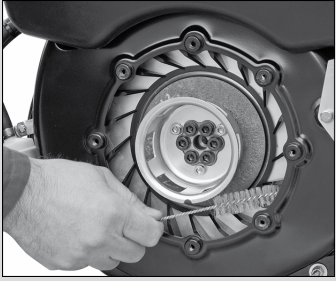
 CAUTION	
	<p>Danger of burns.</p> <p>There is a danger of burns when working on a hot engine.</p> <ul style="list-style-type: none"> ▪ Let the engine cool before maintenance.
 CAUTION	
 	<p>Danger of injury.</p> <p>When working with compressed air, foreign bodies may fly into your eyes.</p> <ul style="list-style-type: none"> ▪ Wear safety goggles. ▪ Never direct the compressed air jet toward people or toward yourself.

Procedure

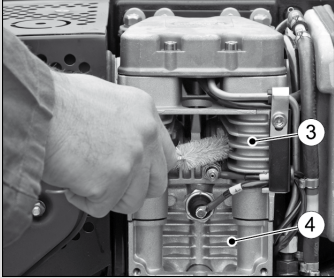
Step	Activity	Figure
Dry contamination		
1	Remove the screws (1).	
2	Take off the recoil start (2) and clean it.	
3	Clean the fan blades with a suitable brush.	
4	Then blow it out with compressed air.	

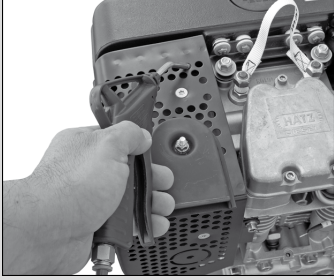
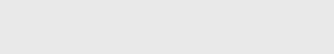
Step	Activity	Figure
5	Also clean the cooling ribs of the cylinder head (3) and cylinder (4) and blow out with compressed air.	
6	<p>Check the air gap (5) for dirt and clean with compressed air if necessary.</p> <p>Note: In 1B20 and 1B27, the air gap (5) is markedly smaller than the gap shown in the figure (size approx. 5 mm).</p>	
7	The element can be checked and cleaned through the holes in the contact guard.	
8	Mount the recoil start (2) again.	
Moist or oily contamination		
1	Contact the HATZ service station.	

8.2.9 Check the screw connections

NOTICE



- Do not retighten the screws for attaching the cylinder head.
- The adjustment screws on the speed governor and the injection system are secured with locking varnish and are not permitted to be tightened or adjusted.
- Only retighten loose screw connections. Screw connections can be secured with thread locking adhesive or tightened to a defined torque. Retightening tight screw connections can cause damage.

Procedure

Step	Activity	Figure
1	Check the condition of all screw connections and ensure that they are tight (for exceptions, see note and picture on the right).	
2	Tighten any loose screw connections.	

8.2.10 Clean the exhaust screen

Safety notes





CAUTION



Danger of burns.

- There is a danger of burns when working on a hot engine.
- Let the engine cool before maintenance.

 CAUTION	
 	<p>Danger of injury</p> <p>There is a danger of injury when performing cleaning work at the exhaust screen.</p> <ul style="list-style-type: none"> Wear safety gloves.



Procedures

The exhaust screen can be cleaned in different ways depending on how the engine is equipped:

- Cleaning the exhaust screen in standard models
- Cleaning the exhaust screen in models for rammer operation (1B20 R)

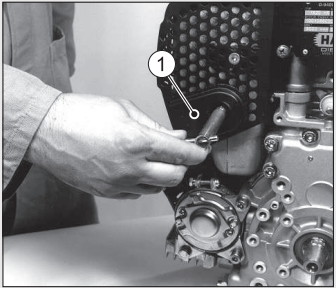
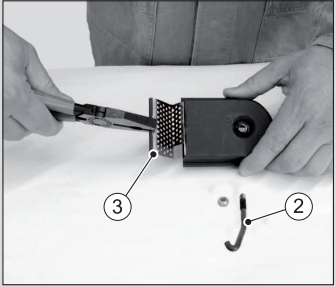

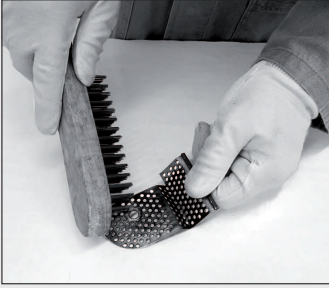
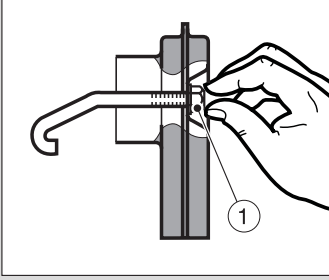
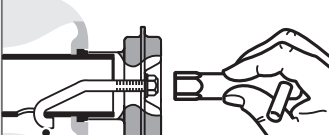
Cleaning the exhaust screen in standard models

Step	Activity	Figure
1	Release the hex nut and take off the exhaust manifold (1).	
2	Remove the hex nut from the bracket (2) and pull out the screen insert (3).	

Step	Activity	Figure
3	Remove the deposits in the screen insert with a suitable wire brush.	
4	Check the screen insert for cracks or breakage, and replace if necessary.	
5	Mount the screen insert and bracket again.	
6	Tighten the hex nut (1) by approx. one turn.	
7	Insert the exhaust manifold with the bracket (2) into the hole and pull it back to the outside so that the bracket can no longer become unhooked.	
8	Tighten the hex nut.	

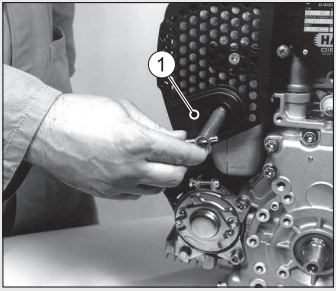
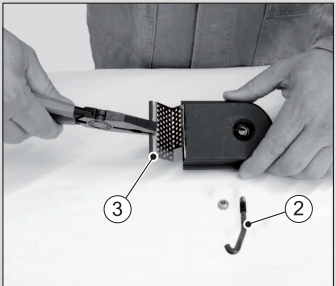
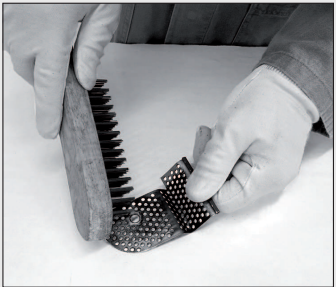
Clean the exhaust screen in models for rammer operation (1B20 R)

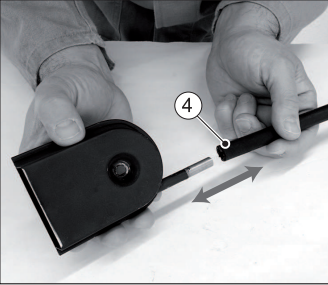
Step	Activity	Figure
1	Release the hex nut and take off the exhaust manifold (1).	
2	Remove the hex nut from the bracket (2) and pull out the screen insert (3).	
3	Remove the deposits in the screen insert with a suitable wire brush.	
4	Check the screen insert for cracks or breakage, and replace if necessary.	

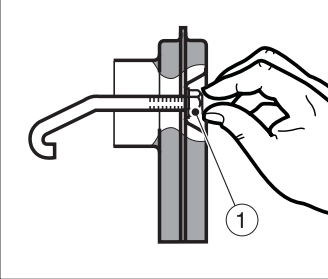
Step	Activity	Figure
5	Pull the hose (4) off of the exhaust manifold.	
6	Check that the pipe connection (5) is clear. Remove deposits using a screwdriver or similar instrument.	
7	Attach the hose again.	
8	Mount the screen insert and bracket again.	
9	Tighten the hex nut (1) by approx. one turn.	

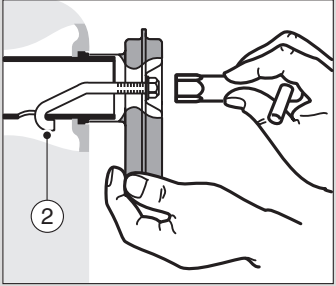
Step	Activity	Figure
10	Insert the exhaust manifold with the bracket (2) into the hole and pull it back to the outside so that the bracket can no longer become unhooked.	
11	Tighten the hex nut.	

8.2.11 Changing the fuel filter

Safety notes

 DANGER	
 	<p>Fire hazard from fuel</p> <p>Leaked or spilled fuel can ignite on hot engine parts and cause serious burn injuries.</p> <ul style="list-style-type: none"> ▪ Do not spill fuel. ▪ No open flames when working on the fuel system. ▪ Do not smoke.
 CAUTION	
 	<p>Danger of injury</p> <p>Repeated contact with diesel fuel can cause chapped and cracked skin.</p> <ul style="list-style-type: none"> ▪ Wear safety gloves.
 CAUTION	
	<p>Danger of environmental damage from spilled fuel.</p> <p>When the filter is removed, a small amount of fuel is drained as well.</p> <ul style="list-style-type: none"> ▪ Collect any escaping fuel and dispose of it according to local environmental regulations.

CAUTION

Dirt particles can damage the injection system.

- Maintain clean conditions to ensure dirt does not enter the fuel line.

Procedures

The fuel filter can be changed in different ways depending on how the engine is equipped:

- Model with fuel filter in tank
- Model with double fuel filter system
- Model with external fuel filter

Model with fuel filter in tank

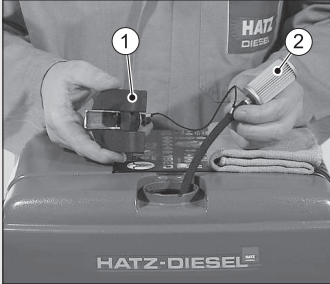
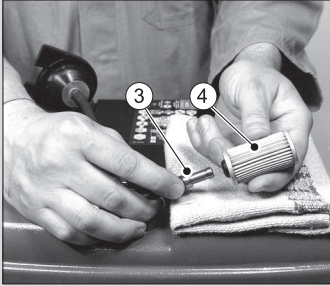
Step	Activity	Figure
1	Open the fuel cap (1) and pull the fuel filter (2) out of the tank by the cord.	
2	Pull the fuel feed line (3) off of the fuel filter (4) and insert a new filter.	
3	Insert the fuel filter back into the tank.	
4	Close the fuel cap. The fuel system is bled automatically.	

Model with double fuel filter system

NOTICE



- The advantage of this system is that dirt particles that may enter the fuel line during a filter change are captured by the downstream outside filter and are therefore unable to endanger the injection system.
- **This outside filter is NOT permitted to be changed. Only change the fuel filter in the tank.**

Step	Activity	Figure
1	Do not change the maintenance-free outside filter (1).	
2	Open the fuel cap (2) and pull the fuel filter (3) out of the tank by the cord.	
3	Pull the fuel feed line (4) off of the fuel filter (5) and insert a new filter.	
4	Insert the fuel filter back into the tank.	

Step	Activity	Figure
5	Close the fuel cap. The fuel system is bled automatically.	

Model with external fuel filter**NOTICE**

In the model with an external fuel filter, there is no fuel filter in the tank.

Step	Activity	Figure
1a	Water separator without window: Empty the fuel tank (1). Open the screw (2) and let the fuel drain into a clean container. The fuel can be used again later.	
1b	Water separator with window: Empty the fuel tank (1). Open the screw (2) and let the fuel drain into a clean container. The fuel can be used again later.	
2	Unscrew the fuel filter (3) from the holder.	

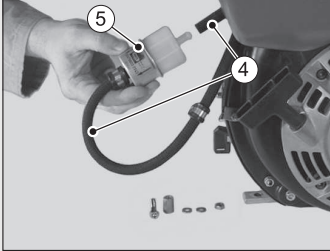
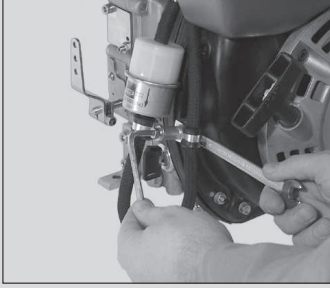
Step	Activity	Figure
3	Place a suitable container under the fuel filter to collect the remaining fuel.	
4	Pull the fuel line (4) off of the fuel filter (5) on both sides and insert a new filter. Observe the flow-through direction (arrows).	
5	Attach the fuel filter to the holder.	
6	Fill the fuel tank with diesel fuel (see chapter 7.7 <i>Refueling</i> , page 50). The fuel system is bled automatically.	
7	Check the fuel filter and lines for tightness after a brief trial run.	

8.2.12 Maintaining the dry air filter

NOTICE



- Immediately clean the filter cartridge if the maintenance display appears at maximum speed.
- Renew the filter cartridge after a use period of 500 operating hours.



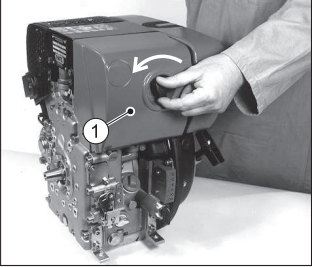
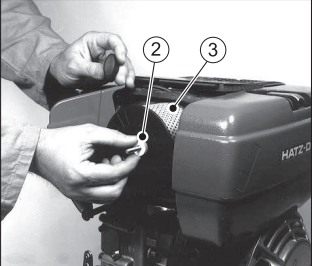
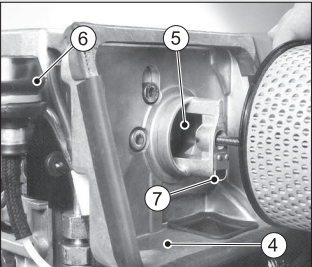

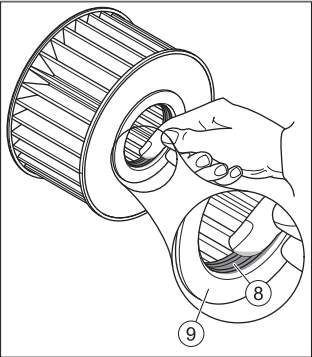
Installing and removing the filter cartridge

Step	Activity	Figure
1	Unscrew the air filter cover (1).	
2	Unscrew the knurled nut (2) and remove the air filter cartridge (3).	
3	Clean the filter housing (4) and cover for the air filter. Ingress of dirt or other foreign bodies into the intake opening (5) of the engine absolutely must be avoided.	
4	In the model with an air filter maintenance display (6), check the condition and cleanliness of the valve shim (7).	

Step	Activity	Figure
5	The air filter cartridge either needs to be replaced, or cleaned or checked depending on the degree of contamination (see chapter 8.2.13 <i>Checking and cleaning the air filter cartridge, page 84</i>).	
6	Thinly coat the gasket (8) with grease or engine oil to make assembly and disassembly of the air filter cartridge easier. Do not coat the face side (9).	
7	Assemble in reverse order.	

8.2.13 Checking and cleaning the air filter cartridge

Safety notes

 CAUTION	
 	<p>Danger of injury.</p> <p>When working with compressed air, foreign bodies may fly into your eyes.</p> <ul style="list-style-type: none"> ▪ Wear safety goggles. ▪ Never direct the compressed air jet toward people or toward yourself.
NOTICE	
	<ul style="list-style-type: none"> ▪ The pressure must not exceed 5 bar. ▪ Even minor damage in the areas of the sealing surface, filter paper or filter cartridge makes it impossible to reuse the filter cartridge.

Checking and cleaning the air filter cartridge

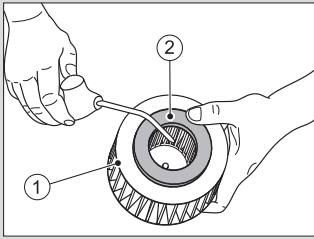
Step	Activity	Figure
Dry contamination		
1	Blow out the filter cartridge (1) with dry compressed air from the inside to the outside until dust no longer emerges.	
2	Check the sealing surface (2) of the filter cartridge for damage.	
3	Check the filter cartridge for cracks in the filter paper and other damage by holding it against the light at a slant or letting light from a lamp shine through it.	
4	Replace the filter cartridge if necessary (see note).	
Moist or oily contamination		
1	Renew the filter cartridge.	

9 Faults

9.1 Troubleshooting

General troubleshooting notes

If the cases listed below have been worked through but the fault continues to persist, please contact your nearest **Hatz service station**.

The engine does not start or is difficult to start, but can be turned easily as usual

Possible causes	Remedy	Chapter
Speed control lever in stop or idle position.	Set the speed control lever to the START position.	<i>7.3 Setting the speed control, page 36</i>
Stop pin in STOP position.	Move the stop pin by pulling it lightly into the operating position.	<i>7.5.1 Switching off the engine (mechanical), page 44</i>
No fuel at the injection pump.	Refuel.	<i>7.7 Refueling, page 50</i>
	Systematically check the entire fuel supply. If this does not yield results:	
	<ul style="list-style-type: none"> ▪ Check the feed line to the engine. 	
	<ul style="list-style-type: none"> ▪ Check the fuel filter. 	<i>8.2.11 Changing the fuel filter, page 78</i>
Injection nozzle is not functional.	Contact Hatz Service.	
Insufficient compression:		
<ul style="list-style-type: none"> ▪ Wrong tappet clearance. 	Check the tappet clearance and adjust if necessary.	<i>8.2.6 Check and set the tappet clearance, page 65</i>
<ul style="list-style-type: none"> ▪ Cylinder and/or piston ring wear. 	Contact Hatz Service.	

If equipped with a fuel shut-off valve or electrical automatic shutoff (engine does not start)

Possible causes	Remedy	Chapter
The fuel shut-off valve is not functional and/or irregularities in the electrical equipment.	Contact Hatz Service.	

For low temperatures (engine does not start)

Possible causes	Remedy	Chapter
Temperature below start limit temperature.	Activate the pre glow system (option).	<i>7.4.2 Starting the engine with a starter, page 39</i>
Pre glow system (option) defective.	Contact Hatz Service.	
Fuel gelled due to insufficient cold resistance.	Check whether the fuel that emerges from the fuel feed line is clear and not cloudy. If the fuel has gelled, either thaw the engine or drain the entire fuel supply system. Fill with a temperature-resistant fuel mixture.	<i>4.5 Fuel, page 26</i> <i>8.2.11 Changing the fuel filter, page 78</i>
Oil is too viscous and causes a too low starter speed.	Change the engine oil. Add engine oil with a suitable viscosity class.	<i>8.2.4 Change the engine oil, page 60</i>
Insufficiently charged battery.	Check the battery and contact the service center if necessary.	<i>3.2.4 Electrical equipment, page 18</i>
Machine is not uncoupled.	If possible, separate the engine from the machine by uncoupling it.	

The engine fires but then fails to continue running

Possible causes	Remedy	Chapter
The speed control lever is not sufficiently set to the Start direction.	Set the lever to the Start position.	<i>7.3 Setting the speed control, page 36</i>
Machine is not uncoupled.	If possible, separate the engine from the machine by uncoupling it.	

Possible causes	Remedy	Chapter
Fuel filter is clogged.	Change the fuel filter.	8.2.11 <i>Changing the fuel filter, page 78</i>
Stop signal from monitoring elements that are associated with the automatic switch-off (optional):		
▪ No oil pressure.	Check the oil level.	7.6 <i>Checking the oil level and adding oil if necessary, page 47</i>
▪ Faulty AC alternator.	Contact Hatz Service.	
▪ Engine temperature too high.	Check the cooling air guides for contamination or other impairments.	8.2.8 <i>Clean the cooling air area, page 70</i>
Fault signal from the overvoltage and polarity protection system in the voltage regulator:		
Battery and/or other cable connections are incorrectly connected.	Check the electrical equipment and its components or contact Hatz service.	3.2.4 <i>Electrical equipment, page 18</i>
Loose cable connections.		

The starter does not switch on and the engine does not turn.

Possible causes	Remedy	Chapter
Irregularities in the electrical equipment:		
Battery and/or other cable connections are incorrectly connected.	Check the electrical equipment and its components or contact Hatz service.	3.2.4 <i>Electrical equipment, page 18</i>
Cable connections are loose and/or oxidized.		
Battery is faulty and/or not loaded.		
Faulty starter.		
Faulty relay, monitoring elements, etc.		

Engine switches off spontaneously during operation

Possible causes	Remedy	Chapter
The tank ran out of fuel during operation.	Fill with fuel.	7.7 <i>Refueling, page 50</i>

Possible causes	Remedy	Chapter
Fuel filter is clogged.	Change the fuel filter.	8.2.11 <i>Changing the fuel filter, page 78</i>
Tank vent is clogged.	Ensure that the tank is sufficiently vented.	
Air in the fuel system.	Check the fuel system for air ingress. Check the bleed valve.	
Mechanical faults.	Contact Hatz Service.	

With automatic electrical switch-off mechanism (option)

Possible causes	Remedy	Chapter
Stop signal of monitoring elements for:		
▪ Oil pressure too low.	Check the oil level.	7.6 <i>Checking the oil level and adding oil if necessary, page 47</i>
▪ Engine temperature too high.	Check the cooling air guides for contamination or other impairments.	8.2.8 <i>Clean the cooling air area, page 70</i>
▪ Faulty AC alternator.	Contact Hatz Service.	
Fault signal from the overvoltage and polarity protection system in the voltage regulator:		
▪ Battery and/or other cable connections are incorrectly connected.	Check the electrical equipment and its components or contact Hatz service.	3.2.4 <i>Electrical equipment, page 18</i>
▪ Loose contacts on cable connections.		

The engine loses power and speed

Possible causes	Remedy	Chapter
The speed adjustment lever does not stay in the desired position.	Block the speed adjustment.	
The fuel supply is impaired:		
▪ The tank ran out of fuel during operation.	Add fuel.	7.7 <i>Refueling, page 50</i>

Possible causes	Remedy	Chapter
<ul style="list-style-type: none"> Fuel filter is clogged. 	Change the fuel filter.	<i>8.2.11 Changing the fuel filter, page 78</i>
<ul style="list-style-type: none"> Inadequate tank venting. 	Ensure that the tank is sufficiently vented.	
<ul style="list-style-type: none"> Air in the fuel system. 	Check the fuel system for air ingress. Check the bleed valve.	

The engine loses power and speed, and black smoke emerges from the exhaust

Possible causes	Remedy	Chapter
Dirty air filter unit.	Check the degree of dirt contamination of the air filter, and clean or renew it if necessary.	<i>8.2.12 Maintaining the dry air filter, page 83</i>
Tappet clearance not OK.	Adjust the tappet clearance.	<i>8.2.6 Check and set the tappet clearance, page 65</i>
Injection nozzle not OK.	Contact Hatz Service.	

Engine becomes very hot. Indicator lamp for engine temperature (option) lights up

Possible causes	Remedy	Chapter
Too much engine oil in the engine.	Drain the engine oil to the upper mark of the dipstick.	<i>7.6 Checking the oil level and adding oil if necessary, page 47</i>
Inadequate cooling:		
<ul style="list-style-type: none"> Contamination in the entire area of the cooling air guides. 	Clean the cooling air area.	<i>8.2.8 Clean the cooling air area, page 70</i>
<ul style="list-style-type: none"> Incompletely closed air guide parts. 	Check the air guide parts and shafts for completeness and good sealing properties.	

Condensate emerges from the exhaust silencer



Possible causes	Remedy	Chapter
Operation under no load or very low load for an extended period.	Operate the machine at a load of approx. 70 % if possible until the exhaust outlet is dry again.	

9.2 Emergency start

If an electrical fault signal occurs, the optional automatic switch-off locks the fuel shut-off valve (1) and thereby stops the fuel supply to the injection pump – the engine switches off. Also, a fault in the electrical equipment can cause the engine to switch off.

If this occurs at a critical location, such as at a railroad crossing or intersection, an emergency start can be activated.

Safety notes

 CAUTION	
	<p>Danger when switching off the engine from the emergency operation mode.</p> <p>During the emergency operation mode, the engine can only be switched off with the starting key if the emergency start lever is first returned to its home position in a clockwise direction.</p>
CAUTION	
	<p>Danger of later engine damage.</p> <p>The monitoring components (oil pressure, charge control and engine temperature) are deactivated in emergency operation.</p> <ul style="list-style-type: none"> ▪ The oil level must be checked before the emergency operation phase.
NOTICE	
	<p>If the emergency operation mode is used, the risk transfers to the operator (the Motorenfabrik HATZ does not accept liability in this case).</p> <ul style="list-style-type: none"> ▪ Immediately after the emergency operation phase, determine the cause of the fault. ▪ Have the Hatz service station supply the emergency start lever with a new lead seal.

Overview

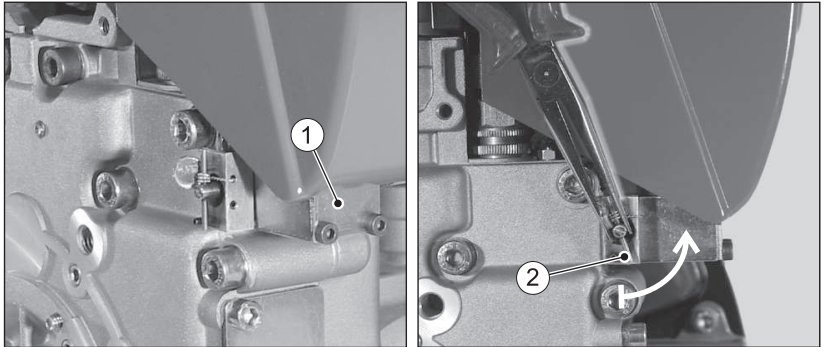

1	Fuel shut-off valve (option)
2	Emergency start lever

Procedure

Step	Activity
1	Using suitable pliers, turn the emergency start lever (2) counterclockwise by at least 90° (seal wire tears). The emergency start lever is now located in the start position, and the fuel shut-off valve (1) is mechanically unlocked.
2	Start the engine with the starter or recoil start (see chapter 7.4 <i>Starting the engine, page 37</i>).
3	Turn the emergency start lever back to the stop in a clockwise direction. Otherwise, it will not be possible to switch off the machine using the starting key.

10 Storage and disposal

10.1 Storing the machine

Safety notes



DANGER



Danger to life from inhaling exhaust gases.

Toxic engine exhaust gases can lead to loss of consciousness and even death in closed-off and poorly ventilated rooms.

- Never operate the machine in closed-off or poorly ventilated rooms.
- Do not breathe in the exhaust gases.



DANGER



Fire hazard from fuel.

Leaked or spilled fuel can ignite on hot engine parts and cause serious burn injuries.

- Only refuel when the engine is switched off.
- Never refuel in the vicinity of open flames or sparks that can cause ignition.
- Do not smoke.
- Do not spill fuel.



CAUTION



Danger of environmental damage from spilled fuel.

Do not overfill the fuel tank and do not spill fuel.

- Collect any leaking fuel and dispose of it according to local environmental regulations.

NOTICE



Comply with the safety chapter!

Follow the basic safety instructions in chapter 3 *Safety*, page 7.

Storing the machine for a lengthy period

Take the following measures if you intend to take the machine out of service for a lengthy period (3-12 months):

Step	Activity
1	Drain the fuel tank until it is nearly empty and fill with FAME*-free fuel. Operate the engine for a few minutes so that only FAME-free fuel is still in the fuel system.
2	Change the engine oil (see chapter 8.2.4 <i>Change the engine oil, page 60</i>).
3	Change the fuel filter (see chapter 8.2.11 <i>Changing the fuel filter, page 78</i>).
4	Let the machine cool down.
5	Remove the battery in accordance with the Operator's Manual for the machine and store at ambient temperature. Comply with the local regulations as well as the regulations of the battery manufacturer for the storage of batteries.
6	Close and seal all engine openings (air intake openings, air outlet openings and the exhaust gas opening) so that no foreign bodies can enter, but a small amount of air can still be exchanged. This avoids condensation.
7	After the machine has cooled down, cover it to protect it against dust and store it in a dry and clean place.

*FAME = Fatty Acid Methyl Ester

Ambient conditions during storage

- Max. permissible storage temperature: -25 °C to +60 °C
- Max. permissible humidity: 70%
- Protect the engine from direct sunlight

Recommissioning

Step	Activity
1	Remove all covers.
2	Check the cables, hoses and lines for cracks and leak tightness.
3	Check the engine oil level.
4	Install the battery in accordance with the Operator's Manual for the machine.

The brand new engine can normally be stored for up to 12 months. The protection lasts up to approx. 6 months at very high humidity and with sea air.

For storage periods of more than 12 months, please contact the nearest **Hatz service**.

10.2 Disposing of the machine

Disposal information

Dispose of the machine (including machine parts, engine oil and fuel) according to the local disposal regulations and the environmental laws in the country of use.

Because of the danger of possible environmental damage, only permit an approved specialist company to dispose of the machine.

NOTICE



When the machine has reached the end of its lifecycle, ensure that it is disposed of safely and properly, especially parts and substances that can be dangerous to the environment. These also include fuel, lubricants, plastics, and batteries (if present).

- Do not dispose of the battery with the household trash.
- Dispose of the battery at a collection point for possible recycling.

11 Installation declaration

Extended Declaration of Incorporation EC Machinery Directive 2006/42/EC

The manufacturer: **Motorenfabrik Hatz GmbH & Co.KG**
Ernst-Hatz-Straße 16
D-94099 Ruhstorf a. d. Rott

hereby declares that the incomplete machine: product description: **Hatz diesel engine**

Type designation and as of serial number:

1B20=10034; 1B20V=11124; 1B20R=14413; 1B27=12514;
1B30=10129; 1B30V=11220;
1B40=11019; 1B40V=11719;
1B50=12416; 1B50V=12616;

satisfies the following basic safety and health protection requirements in acc. with Annex I to the above-mentioned Directive.

- Annex I, General principles no. 1

- Nr. 1.1.2., 1.1.3., 1.1.5., 1.2.1., 1.2.2., 1.2.3., 1.2.4.1., 1.2.4.2., 1.3.1., 1.3.2., 1.3.3., 1.3.4., 1.3.7., 1.3.9., 1.4.1., 1.5.1., 1.5.3., 1.5.8., 1.5.9., 1.6.1., 1.6.2., 1.6.4., 1.7.

All relevant basic safety and health protection requirements down to the interfaces described

- in the operating manual
- in the enclosed data sheets
- in the enclosed technical documents

have been complied with.

The special technical documents in acc. with Annex VII B of the Directive 2006/42/EC have been prepared.

Conformity with the provisions of the following, other EC Directives, i.e.

- **2004/108/EG Electromagnetic Compatibility (EMC)**, dated 15.12.2004

The following standards have been used (completely or partially):

- EN 1679-1: 092011 - EN ISO 12100-1: 032011 - EN ISO 13857: 062008
 - EN 60204-1: 062007

The Operating Manual has been enclosed to the incomplete machine and the Assembly Instructions have been provided to the customer electronically together with the order confirmation.

Commissioning has been prohibited until it has been established, if applicable, that the machine into which the above-mentioned incomplete machine is to be incorporated, satisfies the provisions of the Machinery Directive.

Wolfgang Krautloher / see "Manufacturer"

Name / address of EC documentation officer

15/02/2016

Krautloher / Directives official

Date

Signature and information on the undersigned



Signature

**CALIFORNIA
Proposition 65 Warning**

Diesel engine exhaust and some of its constituents are known to the State of California to cause cancer, birth defects, and other reproductive harm.

Motorenfabrik Hatz GmbH & Co. KG

Ernst-Hatz-Str. 16

94099 Ruhstorf a. d. Rott

Deutschland

Tel. +49 8531 319-0

Fax. +49 8531 319-418

marketing@hatz-diesel.de

www.hatz-diesel.com



CREATING POWER SOLUTIONS.

0000 433 802 11 - 05.2016 - 3

Printed in Germany

EN